

# P90 SPECIFICATION SHEET (WITH PERMA PLEATS AND NF HEADER)

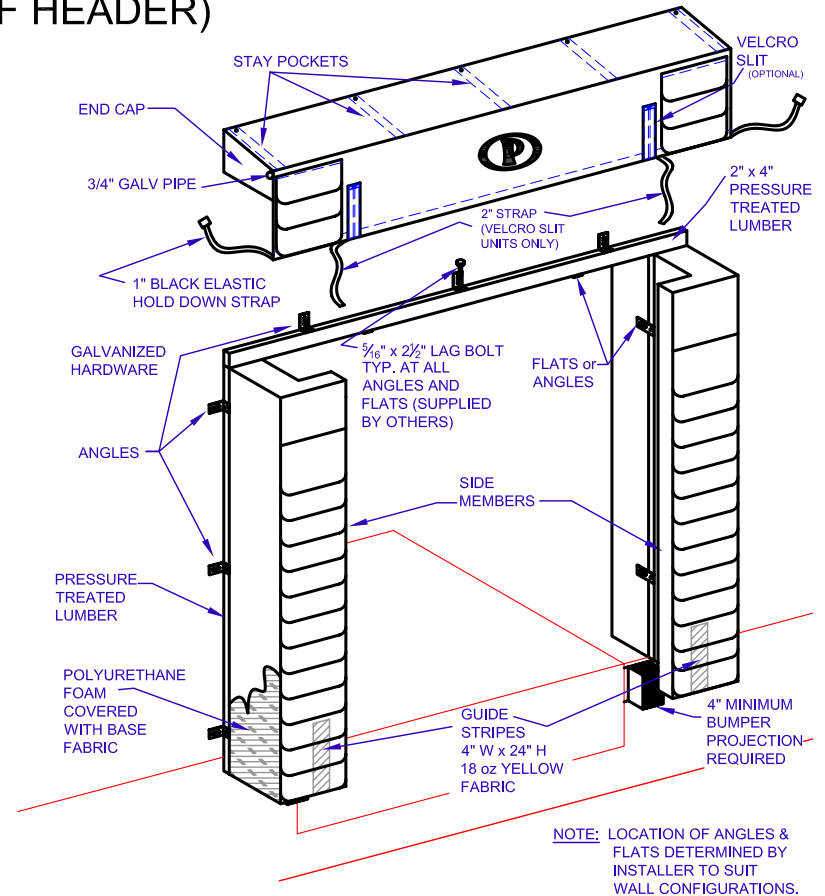

## SIDE PAD MOUNTING VARIATIONS: CIRCLE ONE

Enter Side Pad Face Width:

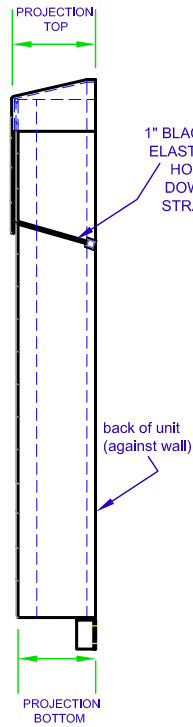
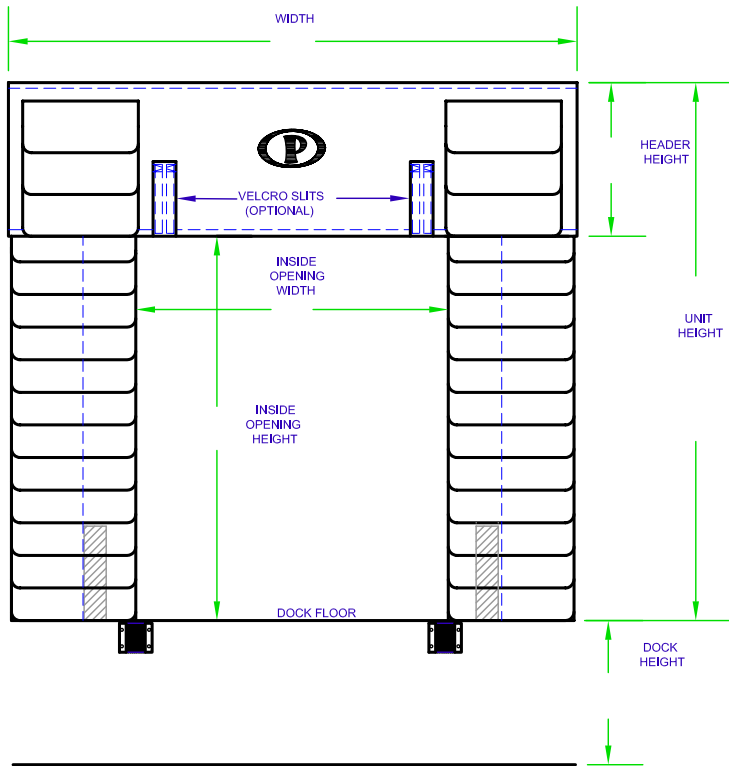
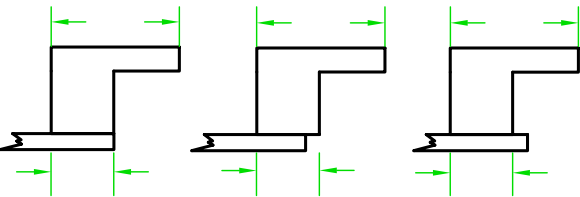

Enter Side Pad Base Width:

NOSE WRAP (SAME AS PLEAT FABRIC)

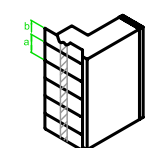
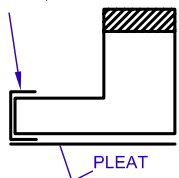

PP4  
a. Exposure 4"  
b. Overlap 4"

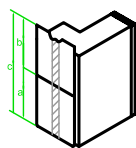

PP8  
a. Exposure 8"  
b. Overlap 10"  
c. Total Length 18"

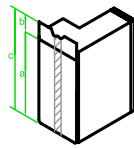

PP16  
a. Exposure 16"  
b. Overlap 2"  
c. Total Length 18"

QUANTITY: \_\_\_\_\_, MODEL: \_\_\_\_\_  
 UNIT SIZE: \_\_\_\_\_ WIDTH, \_\_\_\_\_ HEIGHT  
 HEAD CURTAIN: \_\_\_\_\_ WIDTH, \_\_\_\_\_ DROP  
 INSIDE OPENING WIDTH: \_\_\_\_\_  
 INSIDE OPENING HEIGHT: \_\_\_\_\_  
 PROJECTION: \_\_\_\_\_ TOP, \_\_\_\_\_ BOTTOM  
 SIDE PAD: \_\_\_\_\_ HEIGHT, \_\_\_\_\_ WEDGE  
 CHAIN FLAP: \_\_\_\_\_ WIDTH, \_\_\_\_\_ LENGTH  
 BASE FABRIC: \_\_\_\_\_, COLOR: \_\_\_\_\_  
 FACE FABRIC: \_\_\_\_\_, COLOR: \_\_\_\_\_

DOOR SIZE: \_\_\_\_\_ WIDTH, \_\_\_\_\_ HEIGHT  
 DOCK HEIGHT: \_\_\_\_\_, BUMPER PROJECTION: \_\_\_\_\_  
 APPROACH:  LEVEL  DECLINE  INCLINE  
 \_\_\_\_\_" DIFFERENCE IN 50'-0"

### OPTIONS:

- VELCRO SLIT: \_\_\_\_\_ HEIGHT.  
 3 ROPE PULL-UP  
 UNIT SUPPORT FRAME:  WOOD  STEEL  
 INSIDE WRAP - MATERIAL: \_\_\_\_\_, HEIGHT: \_\_\_\_\_

### SPECIAL INFORMATION



**PERMA TECH, INC.**

363 HAMBURG STREET • BUFFALO, NY 14204  
 (716) 854-0707 • 1-800-DOC-SEAL  
[www.permatechinc.com](http://www.permatechinc.com)

JOB: \_\_\_\_\_

DEALER: \_\_\_\_\_

CONTACT: \_\_\_\_\_

QUOTE #: \_\_\_\_\_

APPROVED BY SIGNATURE: \_\_\_\_\_