

*Soft Cloth*  
**CAR WASH**

**ENTRANCE**



*Soft Cloth*  
**CAR WASH**  
AT ALL TIMES WE RESPECT YOUR  
VEHICLE, HOWEVER, WE ARE  
NOT RESPONSIBLE FOR  
ACCESSORIES THAT HAVE NOT  
BEEN FACTORY INSTALLED,  
ITEMS THAT ARE ALREADY  
DAMAGED OR BROKEN, AND  
ANY LOOSE BUILDING.

# ALASKA

*Polycarbonate Door  
Product Catalog*



**AIRLIFT DOORS, INC.**

Visit our website for the latest updates on products and resources.

The screenshot shows the Airlift Doors, Inc. website homepage. At the top left is the logo with the text "AIRLIFT DOORS, INC. Call toll free at (888) 388-4403". A navigation menu includes "Home", "Products", "Support", "Brochures", "Rates", and "Contact". The main content area features a large image of a "Car Wash" entrance with a roll-up door. To the right is a "Latest News" section with a sub-heading "Important Information from Airlift Doors, Inc." and a small video thumbnail. Below this are three columns: "Alaska Door Packages" with a list of features (Alaska Extreme Door Package, Airlift's Openers, Radiant Heaters) and a "Learn More" button; "XRS Roll-Up Series" with a "Watch Video Demonstration" link and a "Learn More" button; and "Customer Support" with a paragraph about product quality and a "Learn More" button. A "Welcome to Airlift Doors!" section follows, with a paragraph about the company's history and a "Request a Quote" button. A "Featured Products" section is partially visible at the bottom.

**[www.AirliftDoors.com](http://www.AirliftDoors.com)**

- Watch demonstrational videos
- Download installation guides & product brochures
- Get trouble shooting tips or email a technician for help
- Request a quote online or email our experienced sales staff



Find Airlift Doors on Facebook! [www.facebook.com/AirliftDoorsInc](http://www.facebook.com/AirliftDoorsInc)



Find Airlift Doors on Twitter! [www.twitter.com/AirliftDoors](http://www.twitter.com/AirliftDoors)

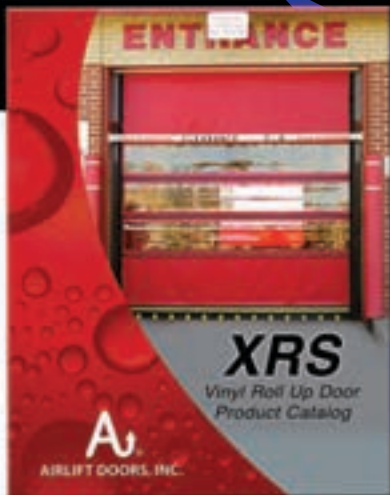

For more information on our other products and catalogs, please call or visit our website!





# COMPLETE INDEX & PRICE LIST REFERENCE

## ALASKA POLYCARBONATE DOOR

Alaska Door Package with Strapeze System.....	Page 3
Alaska Door Package with Torsion Springs.....	Page 4
Alaska Polycarbonate Door Sections.....	Page 5

## HARDWARE FOR ALASKA DOORS

Strapeze Counterbalance System.....	Page 7-8
Torsion Springs.....	Page 9
Shaftline.....	Page 10-12
Track.....	Page 13-14
Drums & Cable.....	Page 15
Hinges & Kits.....	Page 16-18
Rollers & Kits.....	Page 19
Bearings & Bearing Plates.....	Page 20-21
Weatherstrip.....	Page 22
Miscellaneous.....	Page 23

## MAGNAGLIDE AIR OPERATOR

Magnaglide Horizontal Mount.....	Page 25-26
Magnaglide Vertical Mount.....	Page 27-28

## POWERGLIDE AIR OPERATOR

Powerglide Air Opener.....	Page 31-32
----------------------------	------------

## ORIGINAL AIR OPERATOR

Original Air Opener.....	Page 34-35
--------------------------	------------

## CONTROLS -AIR OPERATORS

Control Boxes.....	Page 37-38
--------------------	------------

## ACCESSORIES -AIR OPERATOR

Control Components.....	Page 39-40
Valves.....	Page 41
Photo Eyes.....	Page 42-43
Fittings.....	Page 44

## HEATERS

Infra Red Heaters.....	Page 45-46
Infra Red Heater Replacement Parts.....	Page 47

## FORMS & TERMS

Alaska Door Shop Drawings & Forms.....	Page 49-52
Air Operators Shop Drawings.....	Page 53-55
Warranties.....	Page 56
Credit Requirements.....	Page 57
Credit Application.....	Page 58
Terms.....	Page 59



## Experience Matters:

Airlift Doors, Inc. has been a leader in the commercial door business for over 30 years.

We have been manufacturing air powered openers since 1979 and polycarbonate doors since 1991. We are proud to offer a wide variety of products to meet our customer's needs.

We specialize in car care applications such as car washes, service bays, car dealerships, oil change bays, salt storage sheds, and vehicle showrooms.

We have a strong distributor network set up across the United States and Canada with a presence worldwide.

Call one of our experienced sales staff today and see how Airlift Doors, Inc. can help you find the right products and services today!



# AIRLIFT DOORS, INC.

## Our Mission:

We take pride in the quality of our products and guarantee that no other manufacturer stands behind their products and warranties like we do. With the most options available in the industry, we are sure to help you find the right door and opener for your wash or bay.

## Our Promise:

All standard size doors and openers are guaranteed in stock with the shortest lead times in the industry.

Our customers are important to us and we are there to assist them in every way with technical support available 24 hours a day, 7 days a week.

# 1-888-368-4403

# [www.AirliftDoors.com](http://www.AirliftDoors.com)





**Strong, Durable, Dependable.**

# ALASKA

*Polycarbonate Door*

The Alaska Polycarbonate Door is not your typical overhead door...

## Strength.

The **Alaska** door can withstand **200** times the impact of a glass door while maintaining only 1/8 the weight.



## Durability.

- Designed for carwash environments
- Heavy Duty, Corrosion Resistant Hardware
- 5/8" Five Wall Polycarbonate Panels Standard
- Full Vision Panels Available

## Dependable.

We take pride in the quality of our products and will guarantee that no other manufacturers stand behind their products and warranties like we do.



AIRLIFT DOORS, INC. 



### Alaska Polycarbonate Door Package with **Strapeze® Counterbalance System**



#### Airlift Doors Exclusive Strapeze® Counterbalance System

Recommended for Automated Doors

Average life cycle = 500,000 cycles

Available for doors up to 14' x 12'

Patented by Airlift Doors, Inc.

*Zero maintenance and  
low cost strap replacement!*



- ✓ Anodizing Upgrade Available
- ✓ 1/4" Full Vision Panel Upgrade Available
- ✓ Plastic or Stainless Steel Track Upgrade

#### The Alaska® Door includes:

- Strapeze Counterbalance System
- 5/8" five wall polycarbonate panels
- Sloped mill finish aluminum rails
- 5/32" stainless steel cables
- 3" continuous angle galvanized track

- 3" superglide bearingless or sealed bearing rollers with stainless steel stems
- Nickel plated winding hubs
- Astragal & retainer for bottom section
- Mill finish aluminum end stiles
- Mill finish aluminum center stiles

#### STANDARD ALASKA PACKAGE with Strapeze® Counterbalance System

- 11 gauge galvanized steel hinges
- 1" solid galvanized steel shaft
- Galvanized steel bearing plates
- Standard zerk bearings
- Standard cable drums
- Standard coupler (doors wider than 10')

*\*Stainless steel, Plastic, E-coat & Nickel plated  
hardware upgrades available*

#### ALASKA EXTREME PACKAGE with Strapeze® Counterbalance System

- Durahinge plastic hinges or 12 ga. SS hinges
- Stainless steel hinge screws
- 1" solid stainless steel shaft
- Stainless steel bearing plates
- Stainless steel zerk bearings
- E-coat cable drums
- Nickel plated coupler (doors wider than 12')



**Alaska Polycarbonate Door Package  
with Torsion Springs**



**100,000 Cycle Torsion Springs**

Recommended for Manual or Automated Doors

Available for doors of various sizes up to 24' wide.

Galvanized or Stainless steel springs available.

*Commercial rated and built to last  
in a carwash environment!*



- ✓ Anodizing Upgrade Available
- ✓ 1/4" Full Vision Panel Upgrade Available
- ✓ Plastic or Stainless Steel Track Upgrade

**The Alaska Door includes:**

- 100,000 cycle torsion spring
- 5/8" five wall polycarbonate panels
- Sloped mill finish aluminum rails
- 5/32" stainless steel cables
- 3" continuous angle galvanized track

- 3" superglide bearingless or sealed bearing rollers with stainless steel stems
- Nickel plated winding hubs
- Astragal & retainer for bottom section
- Mill finish aluminum end stiles
- Mill finish aluminum center stiles

**STANDARD ALASKA PACKAGE**  
with Torsion Springs

- 11 gauge galvanized steel hinges
- 1" solid galvanized steel shaft
- Galvanized steel bearing plates
- Standard zerk bearings
- Standard freeway bearings
- Standard cable drums
- Standard coupler (doors wider than 10')

*\*Stainless steel, Plastic, E-coat & Nickel plated hardware upgrades available*

**ALASKA EXTREME PACKAGE**  
with Torsion Springs

- Durahinge plastic hinges or 12 ga. SS hinges
- Stainless steel hinge screws
- 1" solid stainless steel shaft
- Stainless steel bearing plates
- Stainless steel zerk bearings
- Stainless steel freeway bearings
- E-coat cable drums
- Nickel plated coupler (doors wider than 12')



### ALASKA POLYCARBONATE SECTIONS ONLY

Consult factory for sizes available up to 24' wide.

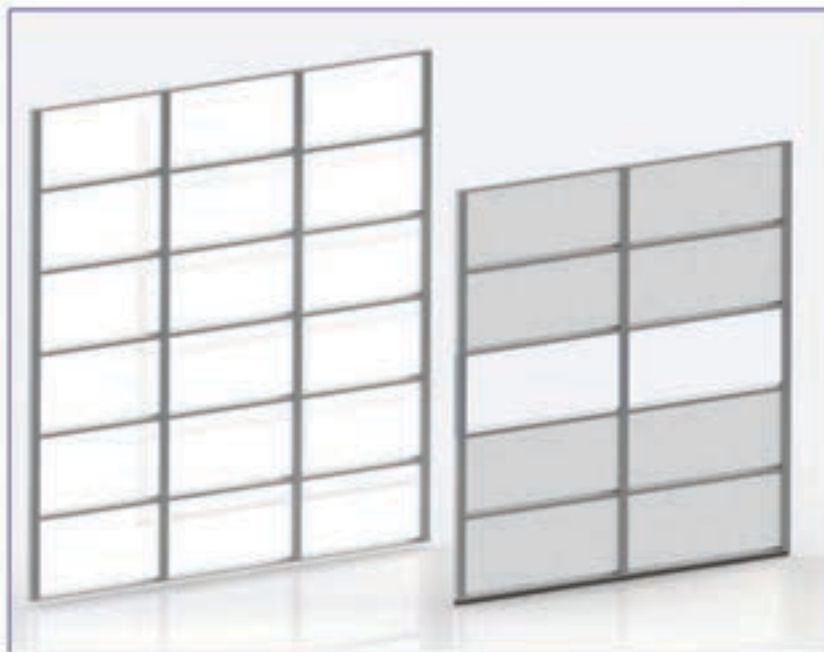

PN# D02100SO	10'2 x 08' SECTIONS ONLY
PN# D02101SO	10'2 x 10' SECTIONS ONLY
PN# D02102SO	10'2 x 12' SECTIONS ONLY
PN# D02104SO	10'2 x 14' SECTIONS ONLY
PN# D02120SO	12'2 x 08' SECTIONS ONLY
PN# D02121SO	12'2 x 10' SECTIONS ONLY
PN# D02122SO	12'2 X 12' SECTIONS ONLY
PN# D02124SO	12'2 X 14' SECTIONS ONLY
PN# D02140SO	14'2 x 08' SECTIONS ONLY
PN# D02141SO	14'2 x 10' SECTIONS ONLY
PN# D02142SO	14'2 X 12' SECTIONS ONLY
PN# D02144SO	14'2 X 14' SECTIONS ONLY

### 1/4" FULL VISION SECTION AVAILABLE IN ALL SIZES

(Consult factory for more information.)

#### INDIVIDUAL FULL VISION INTERMEDIATE SECTION



PN# D03FVS102	10'2 x 24"
PN# D03FVS122	12'2 x 24"
PN# D03FVS142	14'2 x 24"

#### INDIVIDUAL POLYCARBONATE 5 WALL BOTTOM SECTION



PN# D03BSO102	10'2 x 24"
PN# D03BSO122	12'2 x 24"
PN# D03BSO142	14'2 x 24"

#### INDIVIDUAL POLYCARBONATE 5 WALL INTERMEDIATE SECTION



PN# D03ISO102	10'2 x 24"
PN# D03ISO122	12'2 x 24"
PN# D03ISO142	14'2 x 24"



## Parts Guide

# HARDWARE

Polycarbonate Doors



Airlift Doors, Inc. has patented, innovative technology that has been proven to last in harsh car wash environments.

Strapeze<sup>®</sup> Counterbalance System (page 7)

The **Alaska** door offers top of the line hardware and quality you can trust from Airlift Doors.



E-coat Drums (page 15)



Durahinge Plastic Hinge (page 16)



We take pride in the quality of our products and will guarantee that no other manufacturer stands behind their products and warranties like we do.



Superglide Rollers (page 19)



# HARDWARE

Counterbalance System

Strapeze®



## STRAPEZE® COMPLETE KIT



Available for doors  
up to 12' x 12'  
CALL TO ORDER!

## STRAP ONLY



- PN# D04R1199 8' AW-B-99-9-32
- PN# D04R1115 10' AW-B-115-13-37
- PN# D04R1116 11' AW-B-116-53-73
- PN# D04R1142 12' AW-B-140-53-73

## STRAP W/ SPOOLS



- PN# D04R1299 8' AW-B-99-9-32
- PN# D04R1215 10' AW-B-115-13-37
- PN# D04R1216 11' AW-B-116-53-73
- PN# D04R1242 12' AW-B-140-53-73

## STRAP HUB COMPLETE NICKEL PLATED



PN# D04R4022

## WEIGHT 5lb



PN# D04R1009

## WEIGHT 18.9lb



PN# D04R1010

## STRAP ROD



- PN# D04R1014 18"
- PN# D04R1015 21"
- PN# D04R1016 24"
- PN# D04R1017 26"

## GUIDE TUBE ONLY



- PN# D04R1026 10'
- PN# D04R1027 11'
- PN# D04R1028 12'
- PN# D04R1029 13'
- PN# D04R1030 14'



**STRAP KIT 6" NP  
HUBS NO DRUMS**



**PN# D04R4001**

**STRAP SADDLE BRACKET**



**PN# D04R1012 BRACKET (1 PER KIT)**

**PN# D04R1004 STRAP BOLT  
3/8" X 3" (2 PER KIT)**

**PN# D04R1005 STRAP NUT  
NYLOCK 3/8" (2 PER KIT)**

**STRAP SPOOL  
(2 PER KIT)**



**PN# D04R1013**

**STRAP START SPACER  
(1 PER KIT)**



**PN# D04R1007**

**STRAP PIN 1/4"  
(1 PER KIT)**



**PN# D04R1008**

**STRAP WASHER  
(9 PER KIT)**



**PN# D04R1019**

**STRAP HALF KEYWAY  
(1 PER KIT)**



**PN# D04R1020**

**STRAP TUBE BRKT ASSY COMP  
(1 PER KIT)**



**PN# D04R1021**

**STRAP DISK 6" PAIR  
(1 PAIR PER KIT)**



**PN# D04R1024**



100,000 Cycle Galvanized & Stainless Steel Springs



### GALVANIZED TORSION SPRINGS:

- 3 3/4" springs (ID)
- 6" springs (ID)
- Standard winding cones
- Standard stationary cones

### STAINLESS STEEL TORSION SPRINGS:

- 3 3/4" springs (ID)
- 6" springs (ID)
- E-coat winding cones
- E-coat stationary cones
- Corrosion resistant

CONSULT FACTORY FOR SPECIFIC SPRING SIZES THAT FIT YOUR DOOR

When ordering Torsion Springs please provide us with the following:

- Door size
- Number of full vision sections
- Measurements from the floor to the shaft of the door
- For non-polycarbonate doors: please provide the weight of the door including the hardware and struts



**SHAFTLINE FOR TORSION SPRINGS**  
(SPRINGS & DRUMS SOLD SEPARATELY)



- PN# D07R1001 GALVANIZED SHAFTLINE FOR SPRINGS 08'-11' W/ STD BEARINGS
- PN# D07R2001 STAINLESS STEEL SHAFTLINE FOR SPRINGS 08'-11' W/ SS BEARINGS
- PN# D07R2101 STAINLESS STEEL SHAFTLINE FOR SPRINGS 08'-11' W/ STD BEARINGS
- PN# D07R2002 STAINLESS STEEL SHAFTLINE FOR SPRINGS 12'-13' W/ SS BEARINGS
- PN# D07R2102 STAINLESS STEEL SHAFTLINE FOR SPRINGS 12'-13' W/ STD BEARINGS

*This Section of Torsion Spring Shaftlines Include:*

- 1" Solid shaft \* 2-End bearing plates \* 2-Center bearing plates
- 2-Zerk bearings \* 2-Freeway bearings \* 2-Shaft spacers \* Mounting hardware



- PN# D07R1002 GALVANIZED SHAFTLINE FOR SPRINGS 12'-13' W/ STD BEARINGS
- PN# D07R1003 GALVANIZED SHAFTLINE FOR SPRINGS 14'-20' W/ STD BEARINGS
- PN# D07R2003 STAINLESS STEEL SHAFTLINE FOR SPRINGS 14'-20' W/ SS BEARINGS
- PN# D07R2103 STAINLESS STEEL SHAFTLINE FOR SPRINGS 14'-20' W/ STD BEARINGS

*This Section of Torsion Spring Shaftlines Include:*

- 1" Solid shaft \* 2-End bearing plates \* 2-Center bearing plates \* 2-Zerk bearings
- 2-Freeway bearings \* 2-Shaft spacers \* 1" Shaft Coupler \* Shaft keyway \* Mounting hardware

### SHAFTLINE FOR STRAPEZE<sup>®</sup> COUNTERBALANCE SYSTEM (STRAPEZE<sup>®</sup> COMPONENTS & DRUMS SOLD SEPARATELY)



- PN# D07R1004 GALVANIZED SHAFTLINE FOR STRAPEZE 08'-11' W/ STD BEARINGS
- PN# D07R2005 STAINLESS STEEL SHAFTLINE FOR STRAPEZE 08'-11' W/ SS BEARINGS
- PN# D07R2105 STAINLESS STEEL SHAFTLINE FOR STRAPEZE 08'-11' W/ STD BEARINGS
- PN# D07R2006 STAINLESS STEEL SHAFTLINE FOR STRAPEZE 12'-13' W/ SS BEARINGS
- PN# D07R2106 STAINLESS STEEL SHAFTLINE FOR STRAPEZE 12'-13' W/ STD BEARINGS

*Strapeze Shaftlines for doors up to 12' wide include:*

- 1" Solid shaft \* 2-End bearing plates \* 2-Center bearing plates
- 4-Zerk bearings \* 2-Shaft spacers \* Mounting hardware



- PN# D07R1005 GALVANIZED SHAFTLINE FOR STRAPEZE 12'-13' W/ STD BEARINGS
- PN# D07R1006 GALVANIZED SHAFTLINE FOR STRAPEZE 14' W/ STD BEARINGS
- PN# D07R2007 STAINLESS STEEL SHAFTLINE FOR STRAPEZE 14' W/ SS BEARINGS
- PN# D07R2107 STAINLESS STEEL SHAFTLINE FOR STRAPEZE 14' W/ STD BEARINGS

*Strapeze Shaftlines for doors OVER 12' wide include:*

- 1" Solid shaft \* Shaft coupler \* 2-End bearing plates \* 3-Center bearing plates
- 5-Zerk bearings \* 2-Shaft spacers \* Mounting hardware



**FULLY KEYED  
GALVANIZED SHAFT**



PN# D06R1007 1" x 7' 6"  
PN# D06R1012 1" x 12'

**FULLY KEYED  
STAINLESS STEEL SHAFT**



PN# D06R2008 1" x 08'  
PN# D06R2012 1" x 12'  
PN# D06R2014 1" x 14'

**KEYWAY  
1/4" x 1/4" x 3"**



PN# D06R1003

**SHAFT COUPLER  
1" STANDARD**



PN# D06R1001

**SHAFT COUPLER  
1" E-COAT**



PN# D06R4001

**SPACER SHAFT  
PVC 3/4"**



PN# D06R1004

**SHAFT LOCK  
COLLAR 1"**



PN# D06R1000

**Need Assistance?**

Not sure what part you need?  
Call one of Airlift Doors' experienced  
sales team and they will help you  
get your order processed quickly!

**1-888-368-4403**

# HARDWARE

Polycarbonate Door

## Track Complete



2" OR 3"  
AVAILABLE

CONSULT FACTORY  
FOR 2" TRACK

### GALVANIZED STEEL TRACK COMPLETE

- PN# D10R1000 GAL. TRACK 3" x 10' STANDARD RADIUS
- PN# D10R1100 GAL. TRACK 3" x 10' 1-6" STRAIGHT HIGHLIFT
- PN# D10R1101 GAL. TRACK 3" x 10' 7-12" STRAIGHT HIGHLIFT
- PN# D10R1104 GAL. TRACK 3" x 10' BREAKAWAY HIGHLIFT
- PN# D10R1108 GAL. TRACK 3" x 10' VERTICAL LIFT
- PN# D10R1200 GAL. TRACK 3" x 12' STANDARD RADIUS
- PN# D10R1204 GAL. TRACK 3" x 12' BREAKAWAY HIGHLIFT
- PN# D10R1400 GAL. TRACK 3" x 14' STANDARD RADIUS
- PN# D10R1404 GAL. TRACK 3" x 14' BREAKAWAY HIGHLIFT

Consult factory for doors under 10' or over 14'.  
Individual pieces and horizontal or vertical pairs available.  
Complete track includes vertical & horizontal track and fastener kit.

*Airlift Doors, Inc. has been a leader in the commercial door business for over 30 years.*

**AIRLIFT DOORS, INC.**

**EXPERIENCE**

Experience matters.

When you need the best, turn to the experts at Airlift Doors, Inc.



## 304 STAINLESS STEEL TRACK COMPLETE

Complete track includes vertical & horizontal track and fastener kit.



ONLY AVAILABLE IN 3" 5 YEAR WARRANTY

- PN# D10R2100 SS TRACK 3" x 10' STANDARD RADIUS
- PN# D10R2104 SS TRACK 3" x 10' BREAKAWAY HIGHLIFT
- PN# D10R2108 SS TRACK 3" x 10' VERTICAL LIFT
- PN# D10R2200 SS TRACK 3" x 12' STANDARD RADIUS
- PN# D10R2204 SS TRACK 3" x 12' BREAKAWAY HIGHLIFT

Consult factory for doors over 12'.

## PLASTIC TRACK COMPLETE- STAINLESS STEEL ANGLE OR GALVANIZED ANGLE

Corrosion resistant, reduces ice build-up, quiet operation!

ONLY AVAILABLE IN 3"  
5 YEAR WARRANTY

- PN# D10R3101 PLASTIC TRACK 3" x 10' GALVANIZED ANGLE
- PN# D10R3200 PLASTIC TRACK 3" x 12' GALVANIZED ANGLE
- PN# D10R5101 PLASTIC TRACK 3" x 10' STAINLESS STEEL ANGLE
- PN# D10R5200 PLASTIC TRACK 3" x 12' STAINLESS STEEL ANGLE



Consult factory for breakaway highlift plastic track.

## LOW CLEARANCE TRACK OPTION

Low clearance track is an exclusive design from Airlift Doors. It allows your door to travel within 4" of the ceiling and any obstacles.

Fit an overhead door where you never thought you could!  
Available in plastic or galvanized steel.

Consult factory for more information or measurements.  
(See options in complete door prices.)



DRUMS PAIR  
400-144



PN# D12R1001 STANDARD  
PN# D12R5001 E-COAT

DRUMS PAIR  
400-54



PN# D12R1002 STANDARD  
PN# D12R5002 E-COAT

DRUMS PAIR  
5250-18



PN# D12R1003 STANDARD  
PN# D12R5003 E-COAT

DRUMS PAIR  
5250-54



PN# D12R1004 STANDARD  
PN# D12R5004 E-COAT

DRUMS PAIR  
5750-120



PN# D12R1005 STANDARD  
CONSULT FACTORY FOR  
FULL VERTICAL LIFT DRUMS

STAINLESS STEEL  
CABLE PAIR



PN# D13R2120 5/32" x 120"  
PN# D13R2144 5/32" x 144"  
PN# D13R2150 5/32" x 150"  
PN# D13R2165 5/32" x 165"  
PN# D13R2189 5/32" x 189"  
PN# D13R2213 5/32" x 213"

STAINLESS STEEL CABLE  
5/32" PER FOOT



PN# D13R2003

CABLE SLEEVE 5/32"



PN# D13R2006

CABLE STOP 5/32"



PN# D13R2011



## DURAHINGE PLASTIC HINGES

EXCLUSIVE AIRLIFT DOORS DESIGN

- ✓ Stainless steel pin
- ✓ Universal end hinge with multiple roller positions
- ✓ Requires 3" track



AVAILABLE FOR DOORS UP TO 14x12 OR 280 lbs

### PLASTIC HINGE CENTER



PN# D14R3001

### PLASTIC UNIVERSAL END HINGE



PN# D14R3002



**5 YEAR WARRANTY**

CONSULT FACTORY FOR DETAILS

## DURAHINGE PLASTIC HINGE KITS

KIT INCLUDES:

Stainless steel hinge screws, stainless steel bottom brackets, & stainless steel top brackets.



- PN# D16R3100 08-10 x 08
- PN# D16R3101 08-10 x 10
- PN# D16R3102 08-10 x 12
- PN# D16R3120 12-14 x 08
- PN# D16R3121 12-14 x 10
- PN# D16R3122 12-14 x 12

### STAINLESS STEEL HINGES



**5 YEAR WARRANTY**  
12 gauge stainless steel  
Available on ALL size doors

- PN# D14R2001 HINGE #1
- PN# D14R2002 HINGE #2
- PN# D14R2003 HINGE #3
- PN# D14R2004 HINGE #4
- PN# D14R2005 HINGE #5
- PN# D14R2006 HINGE #6
- PN# D14R2007 HINGE #7
- PN# D14R2008 HINGE #8
- PN# D14R2009 HINGE #9

#### TOP BRACKET EACH



PN# D14R2117

#### BOTTOM BRACKET 2/3" COMPLETE



- PN# D14R2116 PAIR
- PN# D14R2114 LEFT ONLY
- PN# D14R2115 RIGHT ONLY

#### BOTTOM BRACKET INDIVIDUAL U CHANNEL



PN# D14R2112



### STAINLESS STEEL HINGE KITS

**KIT INCLUDES:**  
Stainless steel hinge screws,  
stainless steel bottom brackets,  
& stainless steel top brackets.



- PN# D16R2100 3" 08-10 x 08
- PN# D16R2101 3" 08-10 x 10
- PN# D16R2102 3" 08-10 x 12
- PN# D16R2104 3" 08-10 x 14
- PN# D16R2120 3" 12-14 x 08
- PN# D16R2121 3" 12-14 x 10
- PN# D16R2122 3" 12-14 x 12
- PN# D16R2124 3" 12-14 x 14

Consult factory for larger doors.





AIRLIFT DOORS, INC.

# Hinges & Kits

# HARDWARE

Polycarbonate Door

## GALVANIZED HINGES

- PN# D14R1001 HINGE #1
- PN# D14R1002 HINGE #2
- PN# D14R1003 HINGE #3
- PN# D14R1004 HINGE #4
- PN# D14R1005 HINGE #5
- PN# D14R1006 HINGE #6
- PN# D14R1007 HINGE #7
- PN# D14R1008 HINGE #8
- PN# D14R1009 HINGE #9



11 gauge galvanized



CENTER HINGE



END HINGE

Consult factory for hinge sizes greater than #9.

## TOP BRACKET-EACH



PN# D14R1117

## BOTTOM BRACKET 3" COMPLETE



- PN# D14R1116 PAIR
- PN# D14R1114 LEFT ONLY
- PN# D14R1115 RIGHT ONLY

## DOUBLE ROLLER TOP FIXTURE



PN# D14R1119

## GALVANIZED HINGE KITS

FOR DOORS WITH 3" TRACK- CONSULT FACTORY FOR 2"



- PN# D16R1100 3" 08-10 x 08
- PN# D16R1101 3" 08-10 x 10
- PN# D16R1102 3" 08-10 x 12
- PN# D16R1104 3" 08-10 x 14
- PN# D16R1120 3" 12-14 x 08
- PN# D16R1121 3" 12-14 x 10
- PN# D16R1122 3" 12-14 x 12
- PN# D16R1124 3" 12-14 x 14

Consult factory for larger doors.

### SUPERGLIDE ROLLERS

SUPERGLIDE ROLLERS COME WITH ALASKA DOOR PACKAGES

- ✓ Corrosion resistant
- ✓ Stainless steel stem
- ✓ Quiet operation
- ✓ 2" & 3" available
- ✓ UHMW plastic tire
- ✓ 7" stem standard



### LOW CLEARANCE ROLLERS

FOR USE WITH AIRLIFT DOORS  
LOW CLEARANCE TRACK.  
ALLOWS DOOR TO TRAVEL  
WITHIN 4" OF THE CEILING.



PN# D18R3400

CONSULT FACTORY FOR MORE INFORMATION.

### ROLLER BEARINGLESS 3"



PN# D18R3300

### ROLLER SEALED BEARING 3"



PN# D18R3301

### ROLLER SEALED BEARING 2"



PN# D18R3201

### SUPERGLIDE ROLLER KITS



PN# D19R3210 SEALED BEARING 2" x 08'

PN# D19R3211 SEALED BEARING 2" x 10'

PN# D19R3212 SEALED BEARING 2" x 12'

PN# D19R3214 SEALED BEARING 2" x 14'

PN# D19R3300 BEARINGLESS 3" x 08'

PN# D19R3301 BEARINGLESS 3" x 10'

PN# D19R3302 BEARINGLESS 3" x 12'

PN# D19R3310 SEALED BEARING 3" x 08'

PN# D19R3311 SEALED BEARING 3" x 10'

PN# D19R3312 SEALED BEARING 3" x 12'

PN# D19R3314 SEALED BEARING 3" x 14'



HEAVY DUTY BEARINGS & BEARING PLATES  
FOR TORSION SPRINGS  
OR STRAPEZE SHAFTLINE ASSEMBLIES.

ALL BEARING PLATES AVAILABLE IN  
GALVANIZED OR STAINLESS STEEL.



GAL. PLATE END  
LEFT W/ BRG



PN# D21R1101 STD BRG  
PN# D21R1201 SS BRG

GAL. PLATE END  
RIGHT W/ BRG



PN# D21R1102 STD BRG  
PN# D21R1202 SS BRG

GAL. PLATE CENTER  
LEFT W/ BRG



PN# D21R1103 STD BRG  
PN# D21R1203 SS BRG

GAL. PLATE CENTER  
RIGHT W/ BRG



PN# D21R1104 STD BRG  
PN# D21R1204 SS BRG

**GALVANIZED ADJUSTABLE PLATES & BEARINGS**



PN# D21R1105 BEARING PLATE GAL END ADJ LH W/STD BRG  
PN# D21R1205 BEARING PLATE GAL END ADJ LH W/SS BRG  
PN# D21R1106 BEARING PLATE GAL END ADJ RH W/ STD BRG  
PN# D21R1206 BEARING PLATE GAL END ADJ RH W/ SS BRG

### STAINLESS STEEL PLATES & BEARINGS

SS PLATE END  
LEFT W/ BRG



PN# D21R2101 STD BRG  
PN# D21R2201 SS BRG

SS PLATE END  
RIGHT W/ BRG



PN# D21R2102 STD BRG  
PN# D21R2202 SS BRG

SS PLATE CENTER  
LEFT W/ BRG



PN# D21R2103 STD BRG  
PN# D21R2203 SS BRG

SS PLATE CENTER  
RIGHT W/ BRG



PN# D21R2104 STD BRG  
PN# D21R2204 SS BRG

### STAINLESS STEEL ADJUSTABLE BEARING PLATES & BEARINGS



PN# D21R2105 BEARING PLATE SS END ADJ LH W/STD BRG  
PN# D21R2205 BEARING PLATE SS END ADJ LH W/SS BRG  
PN# D21R2106 BEARING PLATE SS END ADJ RH W/ STD BRG  
PN# D21R2206 BEARING PLATE SS END ADJ RH W/ SS BRG

### INDIVIDUAL BEARINGS

FREEWAY STD  
1"



PN# D21R1210

ZERK STD  
1"



PN# D21R1211

FREEWAY SS  
1"



PN# D21R2210

ZERK SS  
1"



PN# D21R2211





AIRLIFT DOORS, INC.

# Weatherstrip

# HARDWARE

Polycarbonate Door

## WHITE VINYL/VINYL SEAL



- PN# D22R1101 10'
- PN# D22R1102 12'
- PN# D22R1103 14'
- PN# D22R1104 16'

## ALUMINUM/VINYL SEAL



- PN# D22R1201 10'
- PN# D22R1202 12'
- PN# D22R1203 14'
- PN# D22R1204 16'

## BRUSH SEAL 2" W/45 DEG. RETAINER



- PN# D22R1401 PER FT

## WHITE CLIP SEAL



- PN# D22R1300 PER FT

## BLACK CLIP SEAL



- PN# D22R1301 PER FT

## ASTRAGAL RETAINER



- PN# D20R1000 08'2"
- PN# D20R1001 10'2"
- PN# D20R1002 12'2"
- PN# D20R1004 14'2"

## "L" SHAPED ASTRAGAL RETAINER



- PN# D20R1011 "L" 10'2"
- PN# D20R1012 "L" 12'2"

## ASTRAGAL



- PN# D20R0000 08'2"
- PN# D20R0001 10'2"
- PN# D20R0002 12'2"
- PN# D20R0004 14'2"
- PN# D20R0099 PER INCH

Download  
Airlift Doors'  
Product Catalog  
Online!

[www.AirliftDoors.com](http://www.AirliftDoors.com)

### PUNCHED ANGLE



- PN# D23R1003 1 1/4" x 8' GALVANIZED STEEL PUNCHED ANGLE
- PN# D23R2003 1 1/4" x 8' STAINLESS STEEL PUNCHED ANGLE

### SECTION CONVEYOR CUTOUT



CONSULT FACTORY TO ORDER

### PUSHER SPRING



- PN# D23R1201 PUSHER SPRING STD LEFT
- PN# D23R1202 PUSHER SPRING STD RIGHT
- PN# D23R2201 PUSHER SPRING SS LEFT
- PN# D23R2202 PUSHER SPRING SS RIGHT

### DUMMY DOOR SECTION



USE WITH DRAWBAR STYLE OPENER  
ON DOORS WITH MORE THAN 12" OF HIGHLIFT  
ALL SIZES AVAILABLE. CONSULT FACTORY TO ORDER.

**THRESHOLD WATERGUARD**  
PREVENTS DOOR FROM FREEZING TO GROUND  
HEAVY DUTY HDPE PLASTIC DESIGN  
FITS ANY OPENING



- PN# D23R1040 12' 4" THRESHOLD WATERGUARD

**AIRLIFT'S EXCLUSIVE CLEANER**  
TESTED & APPROVED BY AIRLIFT DOORS.

- PN# D24R1007  
POLYCARBONATE  
& VINYL CLEANER 1 GAL.

- PN# D24R1008  
ALUMINUM CLEANER  
1 QT.





# MAGNAGLIDE

Air Operator



Horizontal or Vertical mounting available.



The 2" *Magnaglide Air Opener* features direct connect operation and all *stainless steel* hardware.

## Power.

Designed for carwash environments

- Never jump door cables
- Built in wiper seal to eliminate build up
- Completely sealed inner chamber
- Cushioned spring stop

## Operator Packages Include:

- 2" Stainless steel cylinder
- Magnetic carriage
- Magnetic piston
- Stainless steel mounting brackets
- Stainless steel fasteners
- Pusher cylinder kit

## Warranty.

3 YEAR UNCONDITIONAL WARRANTY!

We take pride in the quality of our products and will guarantee that no other manufacturers stand behind their products and warranties like we do.

## Exclusive.

The Magnaglide Air Opener  
is manufactured by  
**A** AIRLIFT DOORS, INC.

# MAGNAGLIDE

*Air Operator*



## MAGNAGLIDE COMPLETE CYLINDERS HORIZONTAL MOUNT INCLUDES ALL BRACKETS & HARDWARE



- PN# O03R2111 OPERATOR MAGNAGLIDE HORIZONTAL 8'
- PN# O03R2135 OPERATOR MAGNAGLIDE HORIZONTAL 10'
- PN# O03R2159 OPERATOR MAGNAGLIDE HORIZONTAL 12'
- PN# O03R2183 OPERATOR MAGNAGLIDE HORIZONTAL 14'

CONSULT FACTORY FOR CUSTOM SIZES. FOR USE ON DOOR WITH MAXIMUM 12' HIGHLIFT.

### BRACKET MG HORIZONTAL KIT



PN# O04R2001

### MAGNAGLIDE CARRIAGE

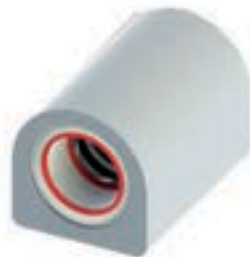

PN# O07R2000 - NEW  
PN# O07R2200 - REBUILT

### PUSHER CYLINDER WITH KNOB



PN# O21R2101

## MAGNAGLIDE HORIZONTAL CYLINDER ONLY INCLUDES CYLINDER & CARRIAGE



- |              |                  |              |                      |
|--------------|------------------|--------------|----------------------|
| PN# O07R2111 | 8' CYLINDER NEW  | PN# O07R2211 | 8' CYLINDER REBUILT  |
| PN# O07R2135 | 10' CYLINDER NEW | PN# O07R2235 | 10' CYLINDER REBUILT |
| PN# O07R2159 | 12' CYLINDER NEW | PN# O07R2259 | 12' CYLINDER REBUILT |
| PN# O07R2183 | 14' CYLINDER NEW | PN# O07R2283 | 14' CYLINDER REBUILT |

REBUILT CYLINDERS AVAILABLE IN LIMITED QUANTITY ONLY.  
CONSULT FACTORY BEFORE ORDERING.





AIRLIFT DOORS, INC.

# MAGNAGLIDE

Air Operator

## MAGNAGLIDE COMPONENTS - HORIZONTAL MOUNT

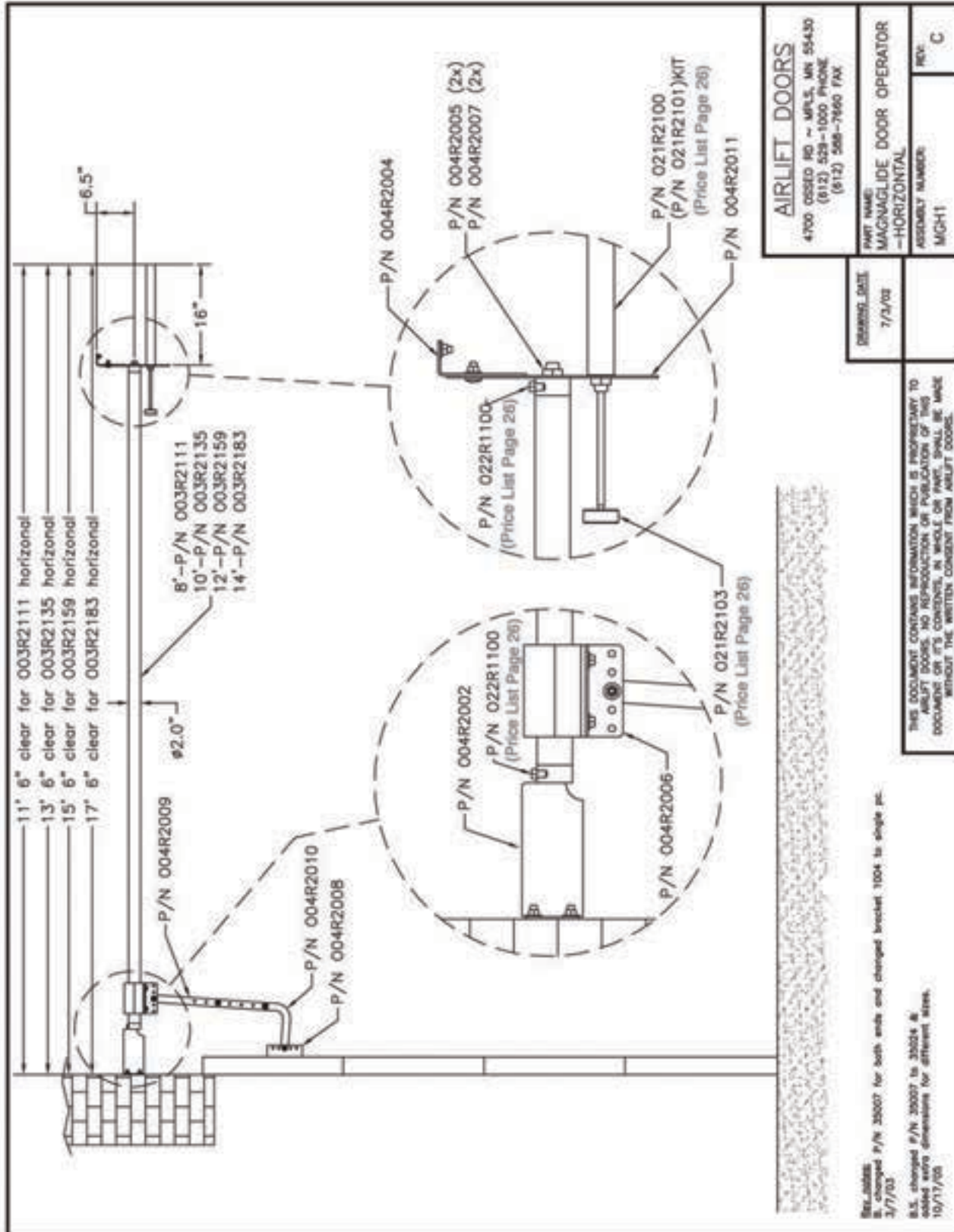

<b>AIRLIFT DOORS</b>	
4700 OSSEO RD - MPLS, MN 55430 (612) 529-1000 PHONE (612) 568-7660 FAX	
PART NAME:	MAGNAGLIDE DOOR OPERATOR
ASSEMBLY NUMBER:	-HORIZONTAL
REV:	C

DRAWING DATE:	7/3/02
---------------	--------

THIS DOCUMENT CONTAINS INFORMATION WHICH IS PROPRIETARY TO AIRLIFT DOORS. NO REPRODUCTION OR PUBLICATION OF THIS DOCUMENT OR ITS CONTENTS, IN WHOLE OR PART, SHALL BE MADE WITHOUT THE WRITTEN CONSENT FROM AIRLIFT DOORS.

Rev. 35007 for both ends and changed bracket 1004 to single pt. 3/7/03  
 P/N 35007 to 35024 & added extra dimensions for different sizes. 10/17/03

# MAGNAGLIDE

*Air Operator*



**MAGNAGLIDE COMPLETE CYLINDERS VERTICAL MOUNT  
INCLUDES ALL BRACKETS & HARDWARE**

**PN# O05R2104 OPERATOR MAGNAGLIDE VERTICAL 8'**

**PN# O05R2129 OPERATOR MAGNAGLIDE VERTICAL 10'**

CONSULT FACTORY FOR CUSTOM SIZES  
AND MINIMUM HIGHLIFT REQUIREMENTS.

**BRACKET MG  
VERTICAL KIT**



**PN# O06R2001**

**PUSHER CYLINDER  
WITH KNOB**



**PN# O21R2101**

**PROTECTIVE SHIELD  
FOR VERTICAL MOUNT**



**PN# O06R2007 104"**

**PN# O06R2009 128"**

**MAGNAGLIDE VERTICAL CYLINDER ONLY  
INCLUDES CYLINDER & CARRIAGE**



**PN# O07R2104 8' CYLINDER NEW**

**PN# O07R2204 8' CYLINDER REBUILT**

**PN# O07R2129 10' CYLINDER NEW**

**PN# O07R2228 10' CYLINDER REBUILT**

REBUILT CYLINDERS AVAILABLE IN LIMITED QUANTITY ONLY.  
CONSULT FACTORY BEFORE ORDERING.





AIRLIFT DOORS, INC.

# MAGNAGLIDE

Air Operator

## MAGNAGLIDE COMPONENTS - VERTICAL MOUNT

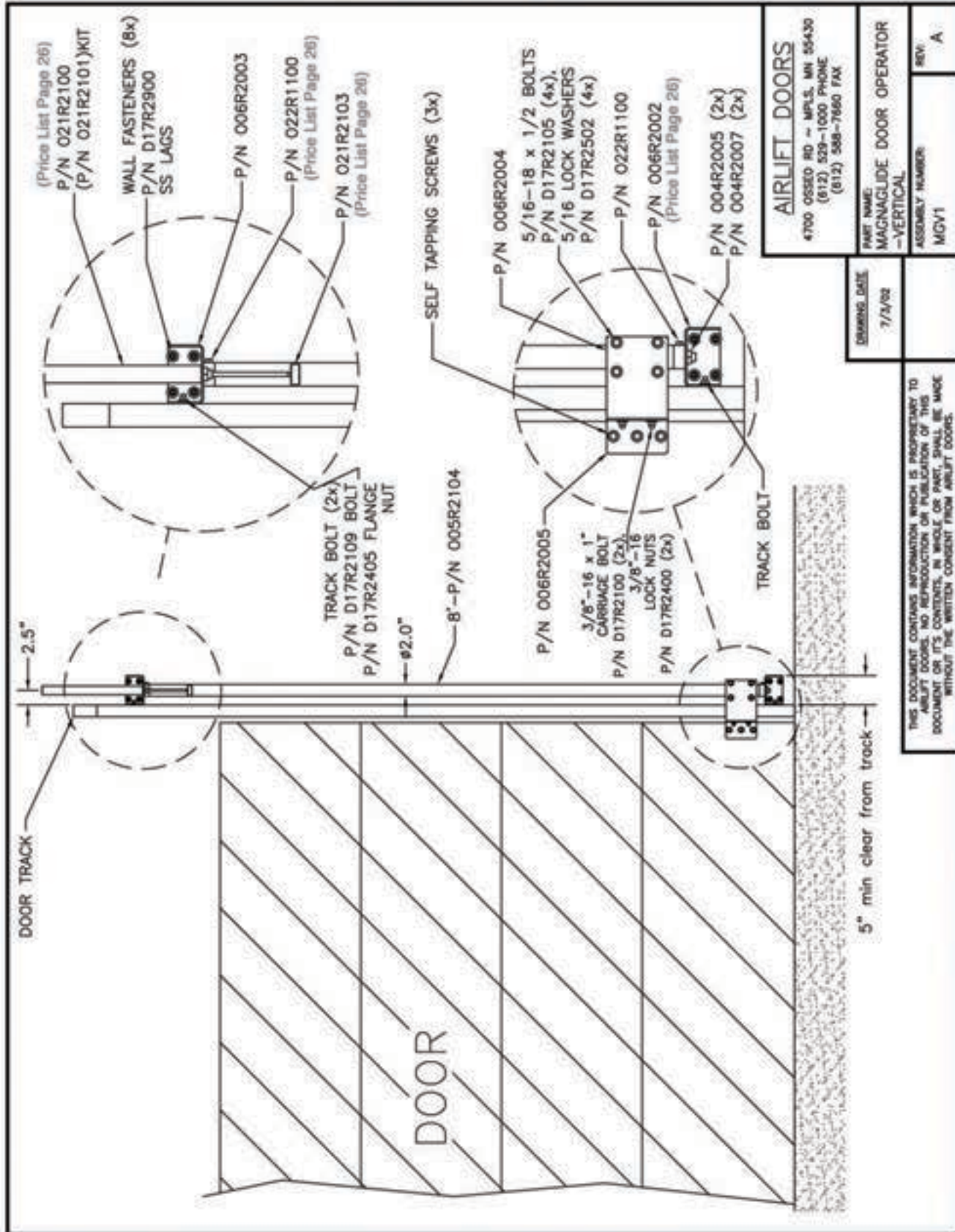

<b>AIRLIFT DOORS</b>	
4700 OSSEO RD - MPLS, MN 55430 (612) 529-1000 PHONE (612) 568-7660 FAX	
PART NAME: MAGNAGLIDE DOOR OPERATOR -VERTICAL	
ASSEMBLY NUMBER: MGV1	REV: A

DRAWING DATE: 7/1/02
-------------------------

THIS DOCUMENT CONTAINS INFORMATION WHICH IS PROPRIETARY TO AIRLIFT DOORS. NO REPRODUCTION OR PUBLICATION OF THIS DOCUMENT OR ITS CONTENTS IN WHOLE OR PART, SHALL BE MADE WITHOUT THE WRITTEN CONSENT FROM AIRLIFT DOORS.

# 24/7 Technical Assistance

Our customers are important to us and we are there to assist them in every way with technical support available 24 hours a day, 7 days a week.

Toll Free: 1-888-368-4403

Download PDF support guides for most of the products offered by Airlift Doors, Inc.



**Support**

Click on the links below to download PDF support guides for most of the products offered by Airlift Doors, Inc. Technical support is also available 24 hours a day, 7 days a week by calling toll free 1-888-368-4403.

**Troubleshooting**  
Troubleshooting the Magnaglide Air Opener and XPS Extreme Roll Up Series.

- [Magnaglide stuck closed](#)
- [Magnaglide stuck open](#)
- [XPS Troubleshooting](#)

**CAD Drawings**  
General CAD drawings of Airlift Products

Click [here](#) to request free drawings in DWG or DXF format.

- [XPS Premium Model Spec Drawings](#)
- [XPS Elite Model Spec Drawings](#)
- [Magnaglide Horizontal Mount](#)
- [Magnaglide Vertical Mount](#)

[www.AirliftDoors.com/support](http://www.AirliftDoors.com/support)



# Power, Performance, Proven **POWERGLIDE** Air Operator



*Exclusive* design to Airlift Doors.

**3 YEAR UNCONDITIONAL WARRANTY!**

## **Power.**

The Powerglide Air Operator has powerful features.

- Direct drive operation
- Rated for doors up to 16 ft. high
- Adjustable speed



## **Performance.**

The ideal opener for car wash environments.

- Never jump door cables
- Unconditional 3 year warranty
- Hardcoat aluminum construction
- Stainless steel hardware
- Built in cushion for smooth operation

The *Powerglide Air Operator* is available in *custom sizes*.

## **Proven.**

Over 10 years in operation in the auto care industry.  
Thousands of customers *prefer* the Powerglide for their car washes.  
Powerglide Air Operators are efficient and low maintenance.

We take pride in the quality of our products and will guarantee that no other manufacturers stand behind their products and warranties like we do.

## POWERGLIDE CYLINDERS COMPLETE WITH BRACKETS HORIZONTAL MOUNT



- PN# O08R2109 OPERATOR POWERGLIDE HORIZONTAL 8'
- PN# O08R2130 OPERATOR POWERGLIDE HORIZONTAL 10'
- PN# O08R2154 OPERATOR POWERGLIDE HORIZONTAL 12'
- PN# O08R2178 OPERATOR POWERGLIDE HORIZONTAL 14'

## POWERGLIDE CYLINDER ONLY



- PN# O08R1109 POWERGLIDE CYLINDER ONLY 8'
- PN# O08R1130 POWERGLIDE CYLINDER ONLY 10'
- PN# O08R1154 POWERGLIDE CYLINDER ONLY 12'
- PN# O08R1178 POWERGLIDE CYLINDER ONLY 14'

### POWERGLIDE BRACKET KIT



PN# O09R2000

### POWERGLIDE CYLINDER REPAIR KIT (BAND SEAL, CABLES, ALL SEALS)



PN# O09R1003-1006

CONSULT FACTORY BEFORE ORDERING

### POWERGLIDE CARRIAGE REPAIR KIT



PN# O09R1018

CONSULT FACTORY BEFORE ORDERING



## POWERGLIDE AIR OPERATOR SPECIFICATIONS - HORIZONTAL MOUNT

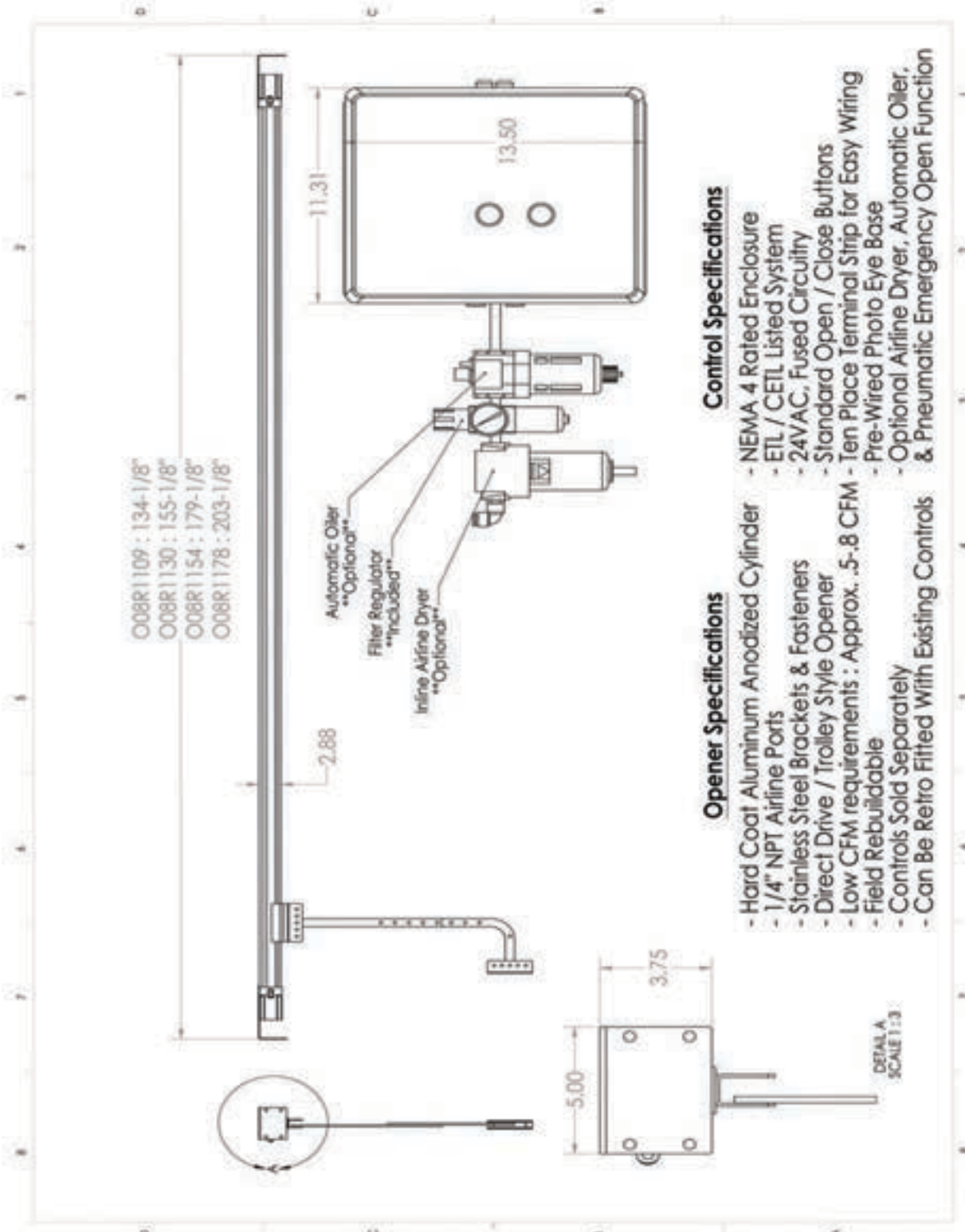

### Control Specifications

- NEMA 4 Rated Enclosure
- ETL / CETL Listed System
- 24VAC, Fused Circuitry
- Standard Open / Close Buttons
- Ten Place Terminal Strip for Easy Wiring
- Pre-Wired Photo Eye Base
- Optional Airline Dryer, Automatic Oiler, & Pneumatic Emergency Open Function

### Opener Specifications

- Hard Coat Aluminum Anodized Cylinder
- 1/4" NPT Airline Ports
- Stainless Steel Brackets & Fasteners
- Direct Drive / Trolley Style Opener
- Low CFM requirements : Approx. .5-.8 CFM
- Field Rebuildable
- Controls Sold Separately
- Can Be Retro Fitted With Existing Controls

# **Air Operator** *Effective, Economical, Established*

*Original Model*



The standard air operator features high speed operation and is ideal for highlift doors.

**Effective.**

**Economical.**

Designed by Airlift Doors specifically for car wash environments.

This air operator has corrosion resistant components and can withstand corrosive environments.

**Established.**

Our standard air operator has been in operation for over 30 years, making it one of the most reliable in the industry with the convenience of being field repairable and rebuildable.



**AIRLIFT DOORS, INC.**

We take pride in the quality of our products and will guarantee that no other manufacturers stand behind their products and warranties like we do.





DUAL AIR OPERATORS REQUIRED FOR DOORS OVER 160 SQ. FT.

OP ORIGINAL HARDWARE KIT 1 OP



PN# O02R9100









OP ORIGINAL REBUILD KIT



PN# O02R9501

## ORIGINAL AIR OPERATOR COMPLETE PACKAGES INCLUDES TEMPERED CHAIN AND HARDWARE KIT

- PN# O01R1108 OP ORIGINAL 8' COMPLETE
- PN# O01R1110 OP ORIGINAL 10' COMPLETE
- PN# O01R1112 OP ORIGINAL 12' COMPLETE
- PN# O01R1114 OP ORIGINAL 14' COMPLETE
  
- PN# O01R2108 OP ORIGINAL 8' DUAL COMPLETE
- PN# O01R2110 OP ORIGINAL 10' DUAL COMPLETE
- PN# O01R2112 OP ORIGINAL 12' DUAL COMPLETE
- PN# O01R2114 OP ORIGINAL 14' DUAL COMPLETE

-  PN# O02R9111 STAINLESS SPROCKET 11 TOOTH
-  PN# O02R9114 STAINLESS SPROCKET 14 TOOTH
-  PN# O02R9201 BOTTOM CAP COMPLETE W/ SEALS
-  PN# O02R9204 PISTON BODY W/ U-CUPS
-  PN# O02R9205 TOP CAP COMPLETE W/ SEALS
-  PN# O02R9208 TOP CAP BRASS NUT W/ ROD SEALS
-  PN# O02R9000 TURNBUCKLE COMPLETE
-  PN# O02R1009 TEMPERED CHAIN W/ TURNBUCKLE -1107 SIZES VARY
-  PN# O02R2009 WATERPROOF CHAIN W/ TURNBUCKLE -2107 SIZES VARY

OP ORIGINAL REBUILD KIT W/ BRASS NUT



PN# O02R9502

CHAIN MASTER LINK



TEMPERED PN# O02R1000

WATERPROOF PN# O02R2000



## ORIGINAL AIR OPERATOR COMPONENTS

### PARTS DIAGRAM

- 1- PN# O02R2401-2409 RETAINING ROD
- 2- PN# O02R2501-2509 ALUM. TUBE
- 3- PN# O02R9506 O-RING
- 4- PN# O02R9210 CHECKBALL
- 5- PN# O02R9202 BOTTOM CAP
- 6- PN# D17R1402 1/4" NUT
- 7- PN# O02R9209 BREATHER VENT
- 8- PN# O02R9211 METERING SCREW
- 9- PN# O02R9301 BOTTOM MTG BRACKET
- 10- PN# O22R1101 3/8 x 1/8 SW AIR FITTING
- 11- PN# O02R9509 PISTON ROD SEAL (2)
- 12- PN# D17R2116 CHAIN GUIDE BOLT
- 13- PN# O02R9102 PISTON ROD COLLAR
- 14- PN# O02R9405 CHAIN ROLLER SLEEVE
- 15- PN# D17R1401 1/4" LOCK NUT
- 16- PN# O02R9404 CHAIN ROLLER
- 17- PN# O02R9401 CHAIN GUIDE BRACKET
- 18- PN# O02R9304 TOP MTG. BRACKET
- 19- PN# O02R2410 RETAINING ROD NUT
- 20- PN# O02R9207 TOP CAP BRASS NUT
- 21- PN# O02R9206 TOP CAP
- 22- PN# O02R2201-2209 PISTON ROD
- 23- PN# O02R9203 PISTON BODY
- 24- PN# O02R9508 U-CUP SEAL
- 25- PN# O02R9402 BRACKET BOLT
- 26- PN# O02R9510 SEAL RETAINER

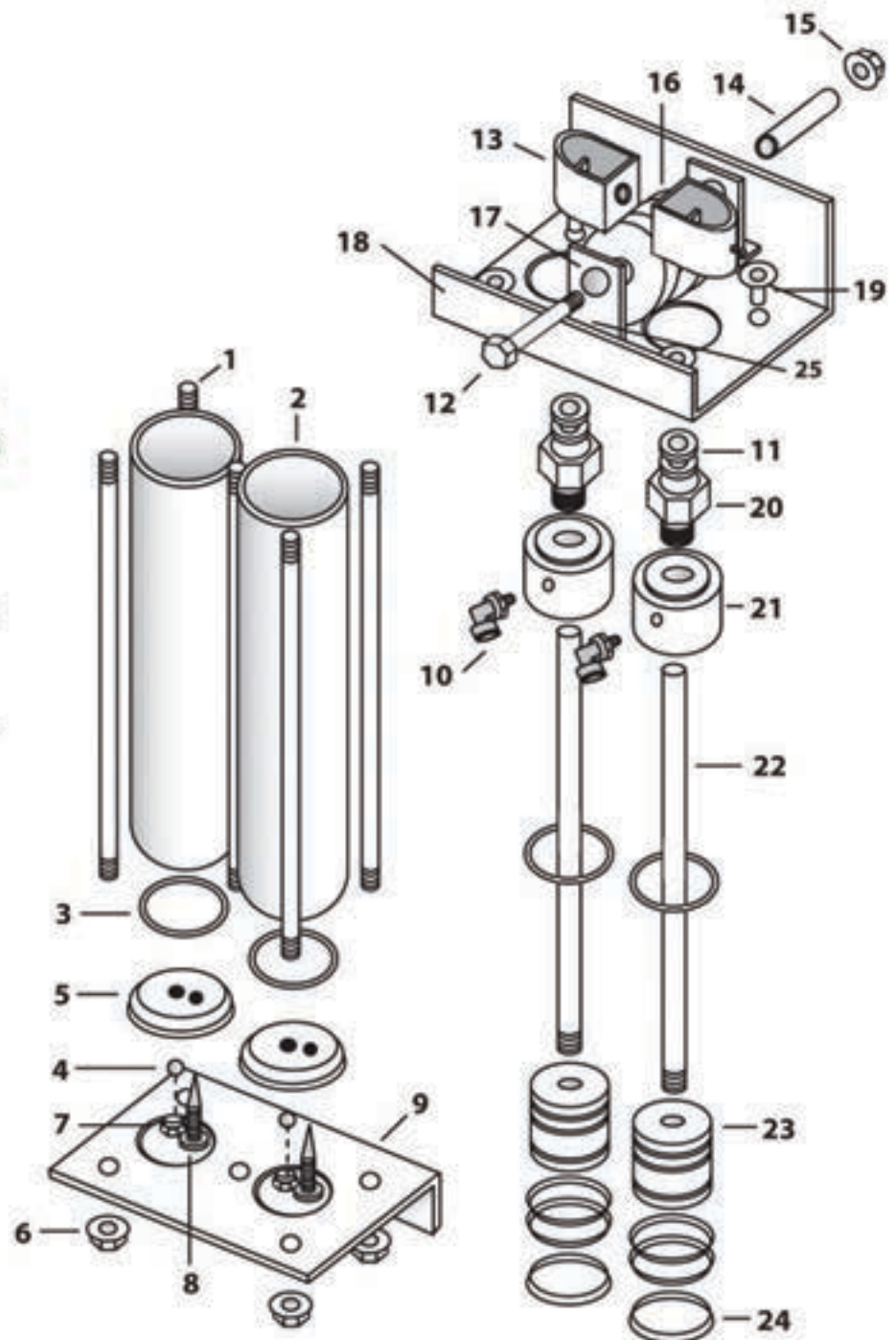

#### ALTERNATE TOP CAP ASSEMBLY FOR OLD STYLE OPERATORS





# *Individual & Multi-Door* **CONTROLS** Control Boxes

Airlift Doors offers a wide variety of control options designed to meet the needs of any application.

The many styles we have available all feature:

- WATERPROOF ENCLOSURES
- HEAVY DUTY FILTER REGULATOR
- HINGED COVER WITH SS SCREWS
- PUSH LOCK AIRLINE FITTINGS
- 24 VAC OPERATION
- ETL & CETL APPROVED



### OPEN/ CLOSE WITH EMERGENCY OPEN



Standard waterproof control boxes can be mounted in the bay or in the equipment room. A heavy duty filter regulator comes standard with each box. The emergency open feature allows you to open the door pneumatically in case of a power failure.

PN# O13R1600 ACCEPTS 24V INPUT

PN# O13R1620 ACCEPTS 110V INPUT

### OPEN /CLOSE WITH EMERGENCY OPEN & LIGHTED BUTTONS



Lighted control boxes show you when a signal is being sent to the open or close terminal by lighting up the corresponding button. The self diagnostic toggle switch allows you to eliminate wash or photo eye signals to determine the source of a constant up or down signal.

PN# O13R1610

### NO BUTTONS



PN# O13R1400

### OPEN/ CLOSE WITH AUTOMATIC CLOSE KIT



PN# O13R1540

### TUNNEL EXIT CONTROL



PN# O13R9200



**MULTI -DOOR CONTROL BOX**

Have a centralized control box for all of your doors. Multi-door control boxes mount in the equipment room and come standard with power toggle switches. Add a timer with toggle switches for complete control of your doors.



**PN# O14R1341 CONTROL MULTI 4 DOOR ETL**

**PN# O14R1351 CONTROL MULTI 5 DOOR ETL**

**PN# O14R1361 CONTROL MULTI 6 DOOR ETL**

**CLOSING TIMER AVAILABLE, SPECIFY PER DOOR QUANTITY.**

**CONTROL WATERPROOF  
BUTTON W/ EYES**

A waterproof two button control box with eyes is mounted in the bay when you have a multi-door control box or standard control boxes mounted in the equipment room. This box offers you button control in the bay and allows you to wire your eyes to this box rather than running wires into the equipment room.



**PN# O15R1003**

**AUTOMATIC DOOR  
CLOSING KIT**

Automatically close your door after each vehicle with an automatic door closing kit and photo eyes. The photo eyes will recognize when the vehicle has left the bay and activate the timer to close the door. Mounts in the bay and has a toggle switch to turn the timer off if not desired. The box with toggle switch is not recommended for self serve bays.



**PN# O15R1000**

A remote emergency open kit allows you to open your doors pneumatically in case of a power failure. This kit is used when you have a multi-door box or standard control box mounted in the equipment room and want an emergency open button in the bay. *(Additional fittings are required to tap into your existing valve. Please consult factory when ordering.)*

**REMOTE E-OPEN  
KIT**



**PN# O15R1013**

**NEMA 4-2 BUTTON  
STATION**



**PN# O15R1009**

Place a two button control box anywhere for open and close control of your door.

# ACCESSORIES

Control Box Components



## MCGANN LOOP KIT

Loop detector kit opens/closes door based on presence of vehicles.



PN# O19R1100

## LOOP DETECTOR



PN# O19R1101

## LOOP DETECTOR HARNESS



PN# O19R1003

## EMX LOOP WIRE 2' x 6'



PN# O19R1006

## REMOTE RECEIVER 2 CHAN DR 2



PN# O19R2015

## REMOTE TRANSMITTER 2 CHAN DT2A



PN# O19R2016

## LIMIT SWITCH COMPLETE



Limit switches recognize when the door is in the down position and will not allow the door to open when the photo eyes are blocked or power returns after an outage.

PN# O18R5002 **LIMIT SWITCH COMPLETE**



### MOELLER CONTACT BLOCK N/O W/BASE



PN# O16R1303 **K10**  
PN# O16R1304 **KC10**

### TITAN BUTTON



PN# O16R1004 **CLOSE LENS**  
PN# O16R1005 **OPEN LENS**  
PN# O16R1002 **BUTTON ONLY**

### BUTTON EMERGENCY CONVERSION KIT



PN# O16R1003

### TELEMACANIQUE CONTACT BLOCK N/O WITH BASE



PN# O16R1305 **ZBE101**

### RELAY 24V W/SOCKET



PN# O19R6001 **SOCKET**  
PN# O19R6000 **RELAY**

### TRANSFORMER 120V-24V



PN# O16R1623

### TOGGLE SWITCH

Add a toggle switch to your control box as an on or off switch for power, timers, or other signals.



PN# O19R4001 **TOGGLE SWITCH**  
PN# O19R4004 **RUBBER BOOT FOR TOGGLE SWITCH**  
PN# O19R4003 **ON/OFF PLATE FOR TOGGLE SWITCH**

### TIMER MACROMATIC W/SOCKET



Closing timer will time out and close the door after any open signal is received. Adjustable from 1 - 180 sec.

PN# O19R3000

# ACCESSORIES

## PNEUMATIC VALVE 2 POSITION PARKER



This valve is the same for a single control box or multi-door box.

PN# O16R1500

## PNEUMATIC VALVE 2 POSITION AUTOMATIC



PN# O16R1501

## PNEUMATIC VALVE 2 FOR MULTI BOX



PN# O16R1502

## INLINE AIRLINE DRYER



PN# O17R1000

## DRYER FLOAT DRAIN



PN# O17R1006

## REGULATOR SMC COMPLETE



PN# O17R3001

## FLOW CONTROL FOR CONTROL BOX



PN# O16R1602 EACH

## OILER CKD L3000



PN# O17R2001

## LUBE CYLINDER 1 QT



PN# D24R1004



## PHOTO EYES

- ✓ RECOMMENDED FOR ALL CONTROL PACKAGES.
- ✓ INSTANTLY REVERSE THE DOOR WHEN OBSTRUCTED.
- ✓ ALL PHOTO EYES ARE CARWASH RATED AND BUILT TO WITHSTAND SOAP BUILDUP, FOG, STEAM, SUNLIGHT, AND HIGH WATER SPRAY.
- ✓ HOLDS DOOR OPEN WHILE SAFETY EYES ARE BLOCKED.

AIRLIFT DOORS PROUDLY OFFERS: CARLO GAVAZZI, TELCO AND BANNER PHOTO EYES.

## TELCO PHOTO EYES

3 YEAR WARRANTY • BUILT IN LEDS • EASY ALIGNMENT • 150' SENSING RANGE  
50' LEAD WIRE • SELF DIAGNOSTIC AMPLIFIER • 24 VAC/DC • 110VAC



PN# O18R1003 SAFETY EYE KIT TELCO

BRACKET SAFETY EYE 10" PR



PN# O18R1501

PIN SOCKET SAFETY EYE



PN# O18R3001

TELCO RECEIVER 50' LEAD WIRE



PN# O18R3503

TELCO TRANSMITTER 50' LEAD WIRE



PN# O18R4503

TELCO AMPLIFIER



24VAC  
PN# O18R4003  
110VAC  
PN# O18R4103

# ACCESSORIES

Photo Eyes



## CARLO GAVAZZI PHOTO EYES

3 YEAR WARRANTY

EASY ALIGNMENT • 150' SENSING RANGE • SELF DIAGNOSTIC AMPLIFIER  
50' LEAD WIRE • 24 VAC/DC



PN# O18R1001 SAFETY EYE KIT CARLO GAVAZZI

BRACKET SAFETY EYE 10" PR



PN# O18R1501

PIN SOCKET SAFETY EYE



PN# O18R3001

CARLO GAVAZZI RECEIVER 50' LEAD WIRE



PN# O18R3501

CARLO GAVAZZI TRANSMITTER 50' LEAD WIRE



PN# O18R4501

CARLO GAVAZZI AMPLIFIER



PN# O18R4001

## BANNER PHOTO EYES



PN# O18R1006 BANNER SAFETY EYE COMPLETE KIT WITH MOUNTING BRACKETS (ROUND TYPE)

PN# O18R3505 BANNER RECEIVER SM30RW3R

PN# O18R4506 BANNER TRANSMITTER SM303E



PN# O18R1005 BANNER SAFETY EYE COMPLETE KIT WITH MOUNTING BRACKETS (SQUARE TYPE)

PN# O18R3506 BANNER RECEIVER SMW95R BLACK

PN# O18R4505 BANNER TRANSMITTER SMA91E YELLOW



**FITTING ELBOW  
3/8" x 1/4" NPT**



PN# O22R1100

**FITTING ELBOW  
3/8" x 1/8" NPT**



PN# O22R1101

**FITTING ELBOW  
3/8"**



PN# O22R1102

**FITTING STRAIGHT  
3/8" x 1/4" NPT**



PN# O22R1103

**FITTING STRAIGHT  
3/8" x 1/8" NPT**



PN# O22R1104

**FITTING TEE  
3/8"**



PN# O22R1105

**FITTING UNION  
3/8"**



PN# O22R1106

**AIRLINE 3/8"  
PER FOOT**



PN# O22R1002

**OPERATOR INSTALL KIT**



PN# O22R1004

# HEATERS

INFRARED



## DX-2 LOW INTENSITY SINGLE STAGE STAINLESS STEEL HEATER

The energy-saving qualities of infrared heating can now be applied in many wet, contaminated or harsh environments with the -SS Series of Stainless Steel Tube Heaters for Re-Verber-Ray.

Heater components are totally enclosed in a moisture resistant silicone sealed stainless steel control housing.



- PN# H01DX2-SS20 HEATER DX2 SS20' 75,000 BTU N/P
- PN# H01DX2-SS30 HEATER DX2 SS30' 100,000 BTU N/P
- PN# H01DX2-SS40 HEATER DX2 SS40' 125,000 BTU N/P
- PN# H01DX2-SS50 HEATER DX2 SS50' 150,000 BTU N/P
- PN# H01DX2-SS60 HEATER DX2 SS60' 150,000 BTU N/P

### DX2 CLEARANCES TO COMBUSTIBLES (IN INCHES)

MODEL NO.	MOUNTING ANGLE*	SIDE		TOP	BELOW
		FRONT	BEHIND		
DX2 (20, 30, 40) - 50, 60 [N.P.]	0°	9	9	6	47
	45°	39	8	10	47
	0°	29	8	6	47
	0°	9	9	6	47
20 ft. from burner	0°	7	7	6	30
DX2 (20, 30, 40) - 75 [N.P.]	0°	9	9	6	60
	45°	39	8	10	60
	0°	29	8	6	60
	0°	9	9	6	60
20 ft. from burner	0°	7	7	6	30
DX2 (20, 30, 40) - 100 [N.P.]	0°	14	14	6	66
	45°	39	8	10	66
	0°	29	8	6	66
	0°	16	16	6	66
20 ft. from burner	0°	7	7	6	30
DX2 (30, 40, 50) - 125 [N.P.]	0°	20	20	6	76
	45°	58	8	10	76
	0°	42	8	6	76
	0°	20	20	6	76
20 ft. from burner	0°	7	7	6	30
DX2 (40, 50, 60) - 150 [N.P.]	0°	24	24	6	81
	45°	58	8	10	81
	0°	42	8	6	81
	0°	23	23	6	81
20 ft. from burner	0°	11	11	6	44

\* Heaters mounted on an angle between 0° and 45° must maintain clearances posted for 0° or 45°; whichever is greater.

#### PRODUCT SPECIFICATIONS

- BTU 75,000 - 150,000
- Gas Type Natural or Propane
- Tube Lengths 20 ft. - 60 ft.
- Combustion Tube 4" dia. Black Coated SS
- Radiant Tubes 4" dia. Black Coated SS
- Certification IAS, CGA, AGA, Outdoor Approval
- U or L Configuration
- Warranty 1-5-10 (Components-Tube-Burner)

#### PRODUCT FEATURES

- Coated 409 or 304 Stainless
- Highly Polished 304 Stainless Reflectors
- Watertight Electrical Connection
- Stainless Steel Hanging Accessories
- 304 Stainless Burner Assembly
- Stainless Steel 24" Pvc Coated flex connector
- Silicone Sealed Construction
- Silicone Carbide Hot Surface Ignition

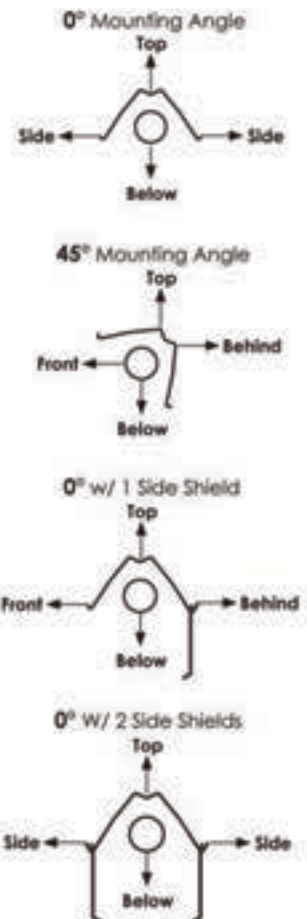



## DR HEATERS - COMPLETE

### HIGH INTENSITY, GAS FIRED, UNVENTED INFRARED HEATERS

The DR Series is commonly used in areas with high air infiltration, high ceilings and/or spot heating applications. The DR Series is available in a multitude of configurations, ranging from 30 to 160 MBTU/H with 3 different control options.

The DR Series of infrared heaters is ideal in applications where unvented high intensity heat offers design benefits or is preferred.

The DR Series is also ideal for unvented spot heating applications.

**NOT FOR USE IN CARWASH BAYS.**

#### STANDARD FEATURES:

- 5 year limited ceramic burner warranty.
- Exclusive Re-Verber-Ray ceramic burner provides maximum conversion to infrared radiation.
- Design A.G.A. Certified, U.L. Listed, accepted by F.I.A. and F.M.
- 3 different heater control systems - from manual to solid state ignition.
- Lower installation cost through compact modular heater design.
- Rugged non-corrosive materials in heater construction.
- Proven design, over 2,000,000 burners in use.
- Select high temperature, Re-Verber-Ray-tor rods increase heater temperature and efficiency.

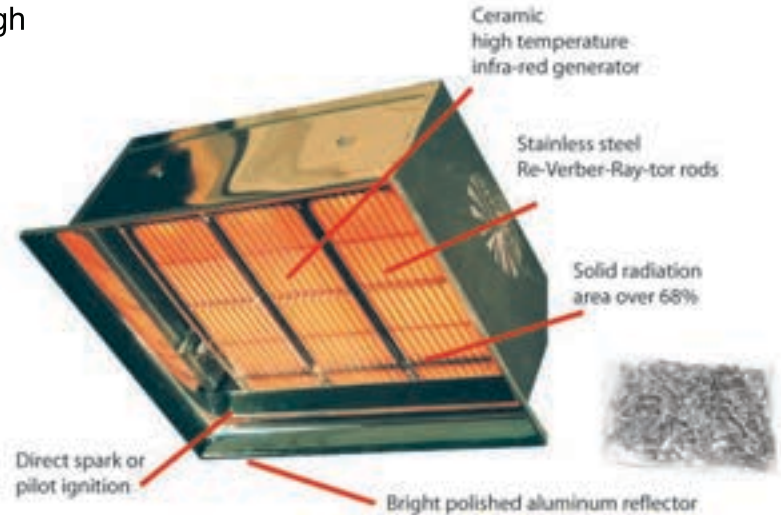

- PN# H05DR-30 HEATER DR 30,000 BTU
- PN# H05DR-60 HEATER DR 60,000 BTU
- PN# H05DR-75 HEATER DR 75,000 BTU
- PN# H06DRCS HEATER DR CHAIN SET

#### CLEARANCES TO COMBUSTIBLES(IN.)

MODEL NO.	SIDES	BACK	TOP	BELOW
DR 30	30	18	28	72
DR 30(S)	30	18	28	72
DR 60	32	18	40	72*
DR 75	48	30	42	98

\* Clearance is 80 in. when heater is fitted with a parabolic reflector.



CLEARANCES TO COMBUSTIBLES DIAGRAM: FRONT VIEW



CLEARANCES TO COMBUSTIBLES DIAGRAM: SIDE VIEW

#### DR SERIES ORDERING INSTRUCTIONS

**Model Number Format.** DR (BTU) (Gas Type) (Ignition Type) (Voltage). Example DR 60 NFS-2 120V

N= Natural Gas, P= Propane Gas

NMV-2/PMV-2= Manual Ignition, Constant Pilot, 100% Shutoff, Self Energizing. Includes RK-130 T-Stat and 35' of wire

MV Models are NOT for use in high wind applications

NFS-2/PFS-2= Direct Spark Ignition, 100% Shutoff. Specify 24V or 120V

**Note:** Circuit boards are potted on all models

# HEATERS

PARTS & ACCESSORIES

THERMOSTAT  
RAIN TIGHT



PN# H02TF-115

4" INLET W/BIRDSCREEN



PN# H02WIV-4

4" ROOF TOP VENT  
PACKAGE



Interior venting  
not included.

PN# H02RTVP-4

STAINLESS STEEL CHAIN



PN# H02THCS-SS PER FT  
PN# H02THCS 5' W/S HOOKS

4" TUBE HANGER



PN# H02TP-19B

HEATER REFLECTOR  
BRACKET



PN# H02BK

TUBE COUPLER



PN# H02TP-220 4" SS

GLO-BAR IGNITER



PN# H02TP-50

HEATER 180° U-BEND  
PACKAGE

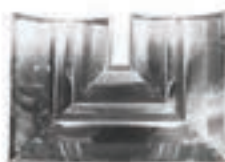

PN# H02RUP-SS

HEATER 90° ELBOW  
PACKAGE



PN# H02REP-SS



# Important Information...

# TERMS

TERMS & FORMS

In this section Airlift Doors has included all of the important information that is necessary when ordering doors & openers.

Included in this section are:

- Shop Drawings
- Engineering Forms
- Measurement Forms
- Warranty Information
- Credit Application Requirements
- Terms & Conditions

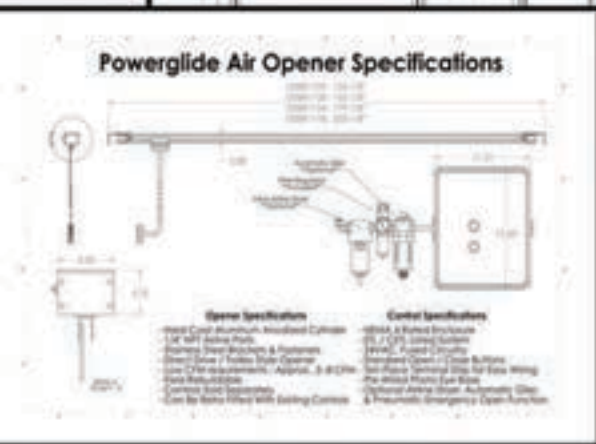
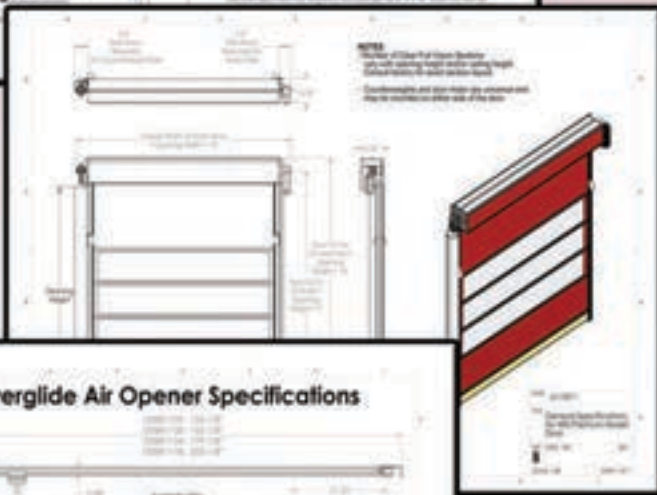
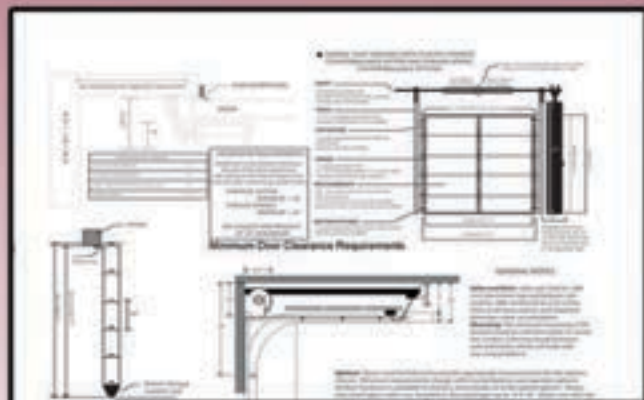

## ALASKA DOOR WITH SPRINGS SHOP DRAWING

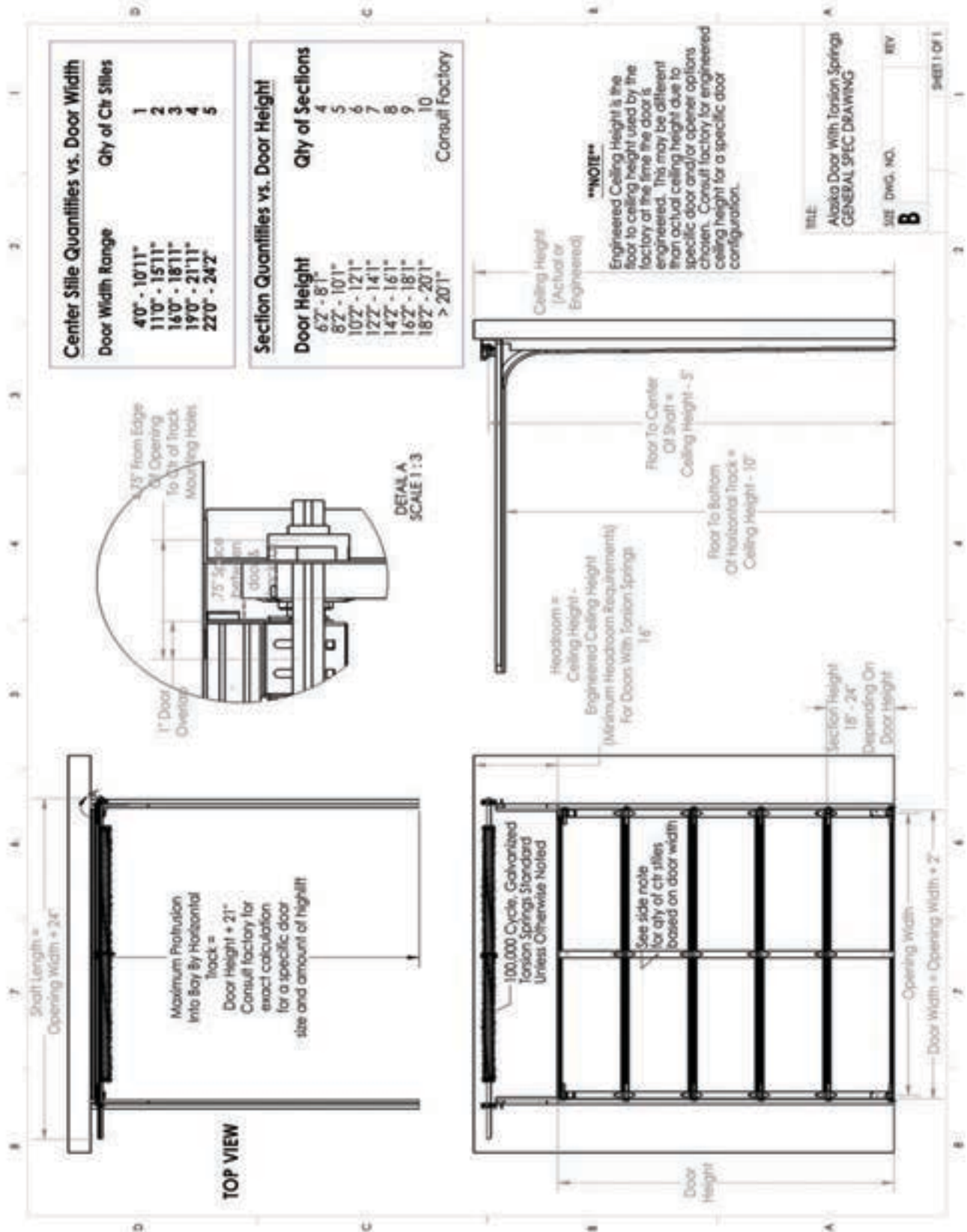



## ALASKA DOOR WITH STRAPEZE<sup>®</sup> SHOP DRAWING

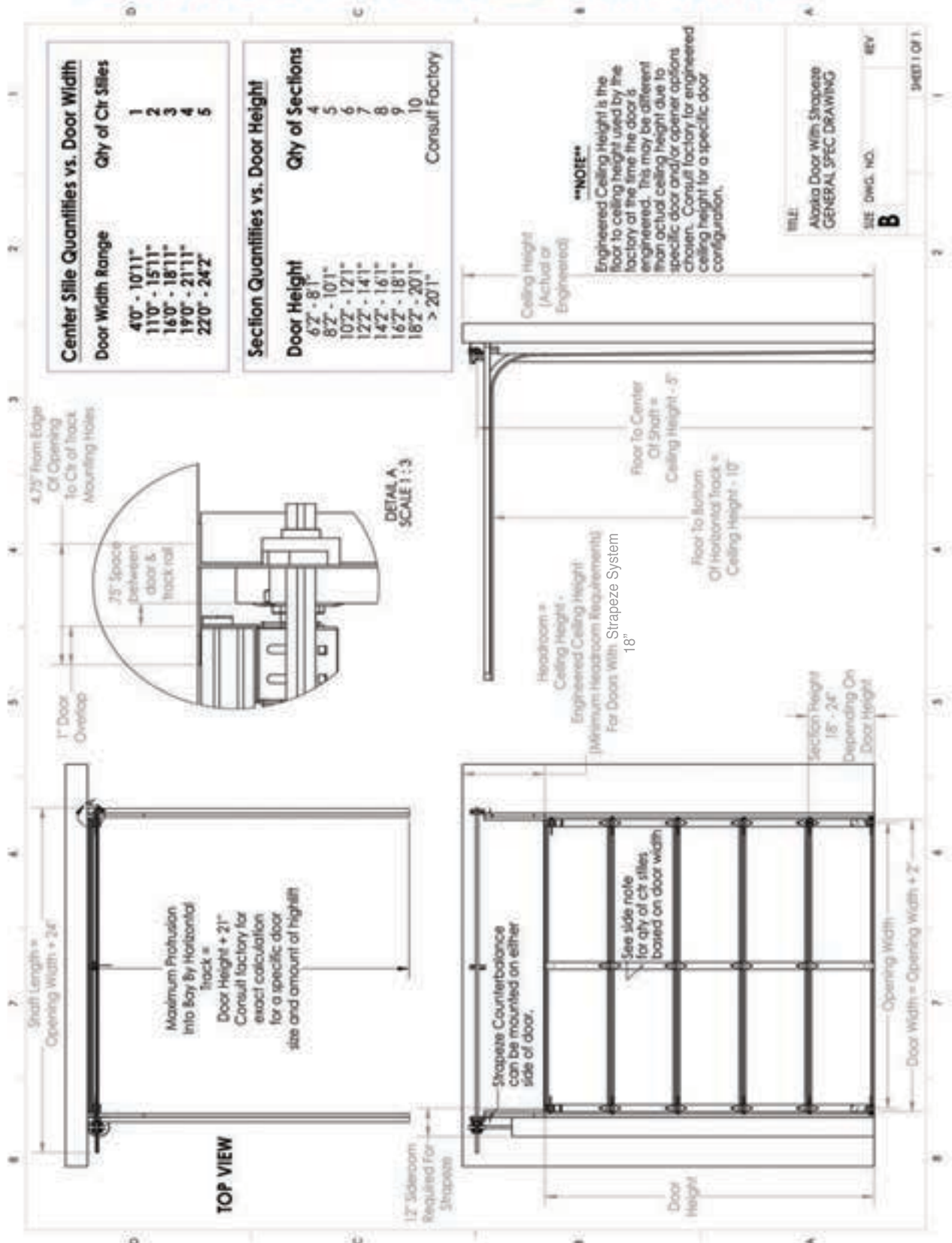

## ALASKA DOOR ENGINEERING FORMS

Please complete this form and return it to your sales representative so we can properly quote or engineer your order. Please measure carefully and remember to note any objects that may be in the path of the overhead door travel.

Orders may not be engineered before the receipt of this form.

PLEASE CIRCLE ONE

**ENTER / EXIT / BOTH DOORS**

If any measurements vary please fill out a measurement form for each door opening.

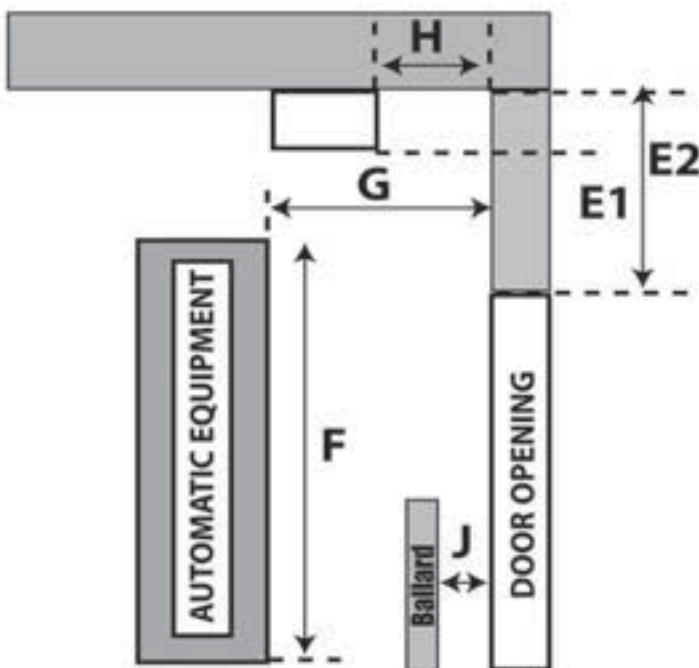
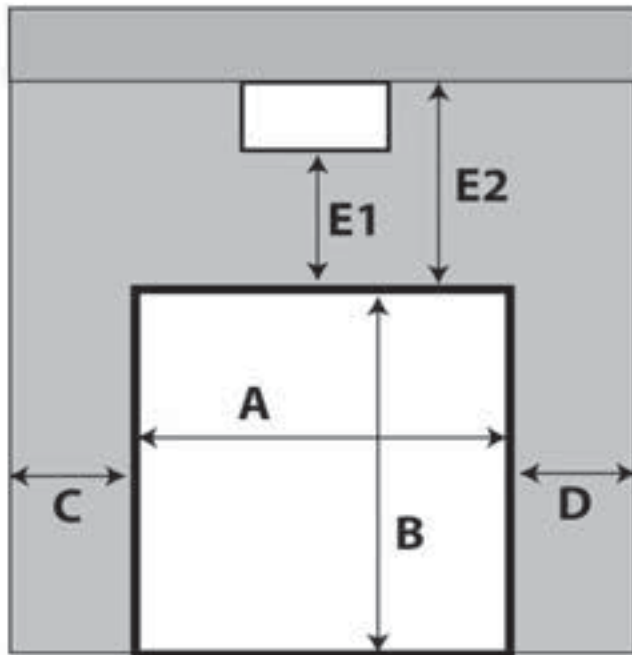

A: Finished Opening Width \_\_\_\_\_

B: Finished Opening Height \_\_\_\_\_

C: Left Sideroom \_\_\_\_\_

D: Right Sideroom \_\_\_\_\_

E1: Headroom to Obstacle \_\_\_\_\_

H: Backroom to Obstacle \_\_\_\_\_

E2: Headroom to Ceiling \_\_\_\_\_

F: Equipment Height \_\_\_\_\_

G: Backroom \_\_\_\_\_

J: If ballards exist please provide measurement  
from ballard to wall \_\_\_\_\_

Jamb Material: WOOD / CONCRETE / STEEL

OR Please Specify ANGLE IN / OUT

Ceiling Material \_\_\_\_\_

Wall Material \_\_\_\_\_

Building Type: BLOCK TIN WOOD

OTHER: \_\_\_\_\_

By signing below I understand that the doors will be engineered specifically to the measurements I have supplied on this form. I take full responsibility for all information supplied on this form.

Reference Quote # \_\_\_\_\_

Signed by: \_\_\_\_\_

Date \_\_\_\_\_



## ALASKA DOOR CONVEYOR CUTOUT

### SINGLE CONVEYOR CUT-OUT DIAGRAM

**\*\*View of section is from inside the bay looking out.\*\***

Fill in measurements for one side for a single conveyor cutout  
Fill in all measurements for a double conveyor cutout



**\*\*NOTE:** The door section will generally be 2" wider than the door opening itself and will overlap each edge by 1". Please factor this extra 1 inch into your measurement for letters A and D.

A: \_\_\_\_\_ Measurement from **edge of door** to edge of cut out D: \_\_\_\_\_

B: \_\_\_\_\_ Height of cut out E: \_\_\_\_\_

C: \_\_\_\_\_ Width of cut out F: \_\_\_\_\_

By signing below I understand that the conveyor cut-out will be made exactly to these measurements I have provided.

SIGN HERE: \_\_\_\_\_

## MAGNAGLIDE HORIZONTAL SHOP DRAWING

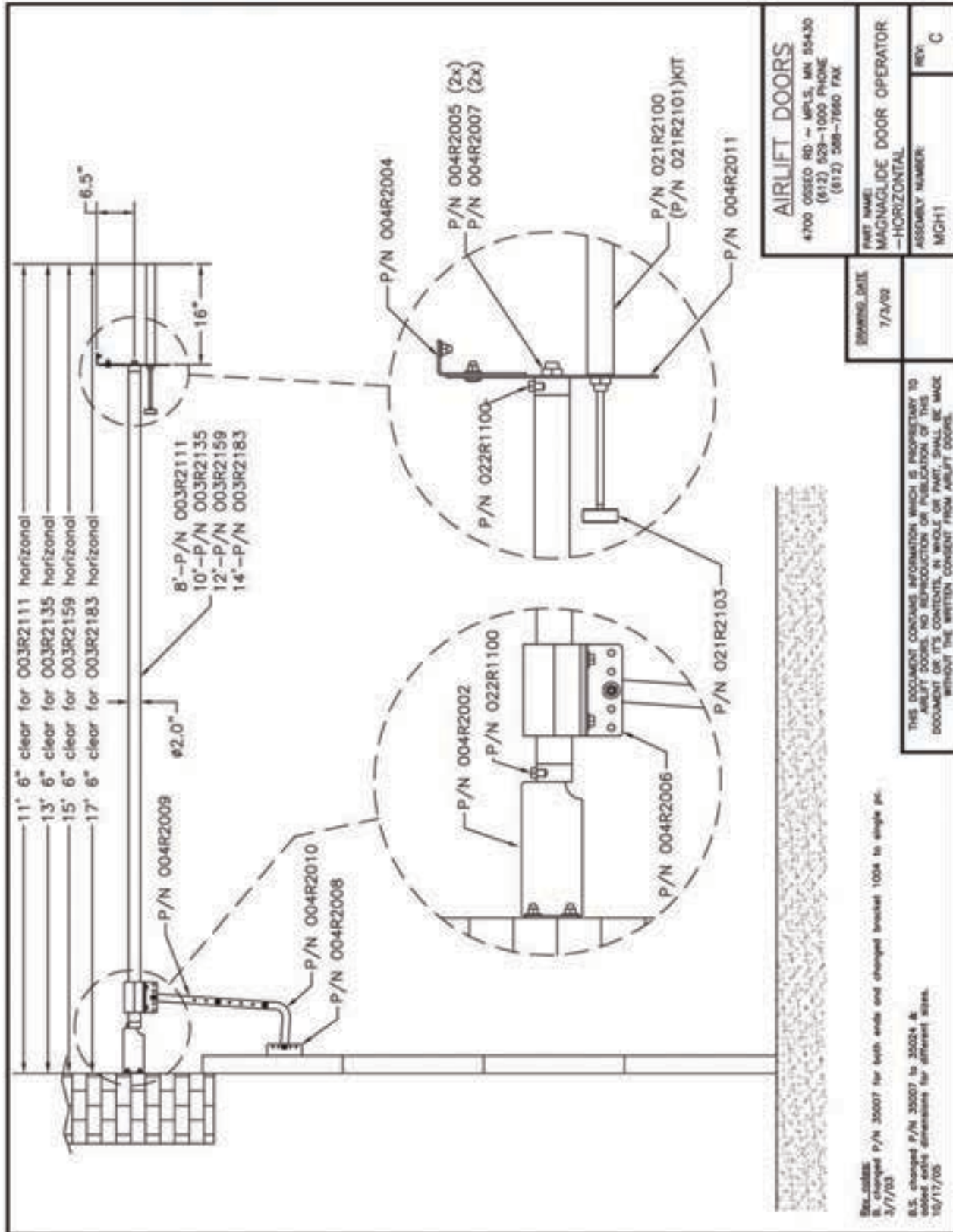



## MAGNAGLIDE VERTICAL SHOP DRAWING

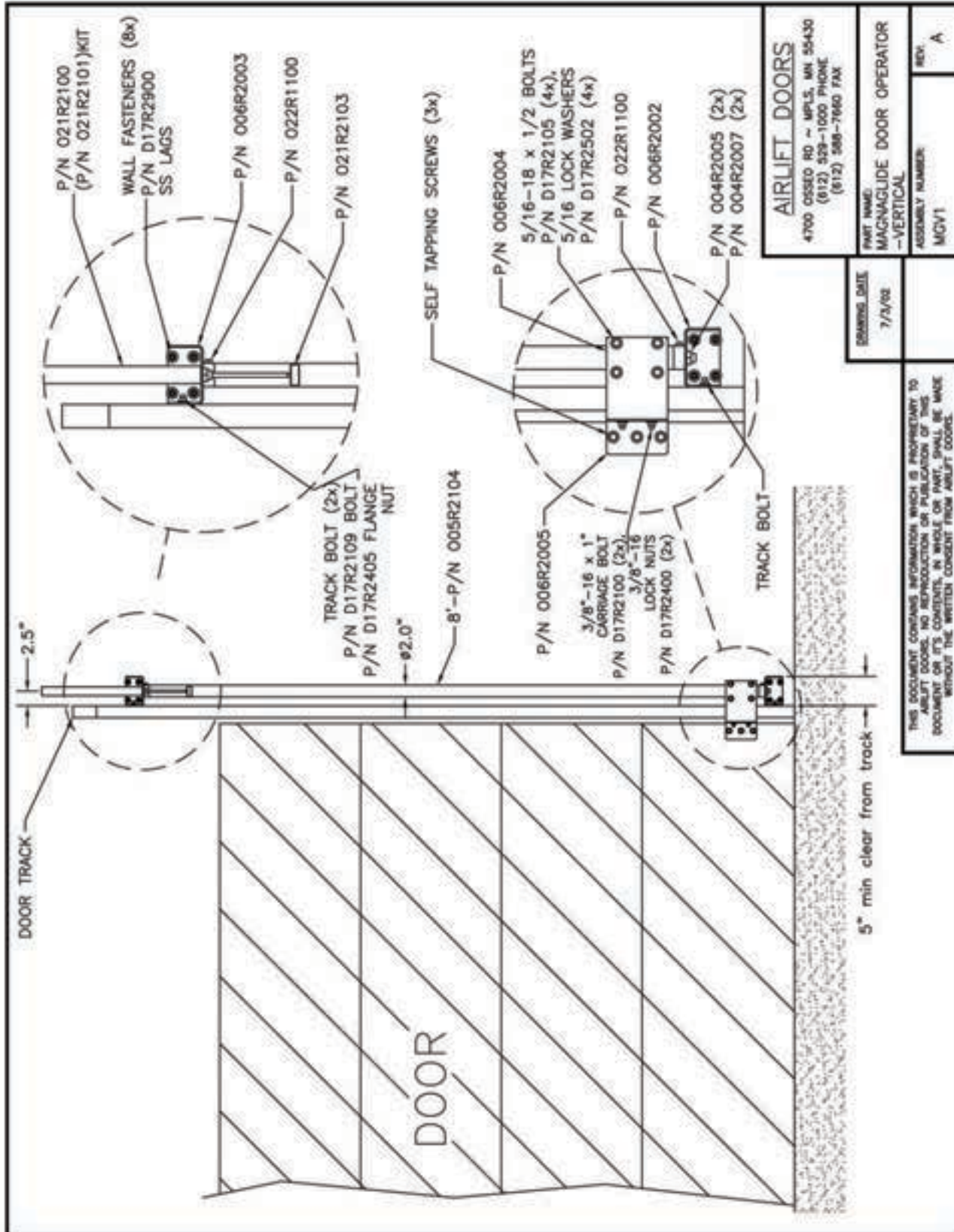

<b>AIRLIFT DOORS</b>		REV. A	
4700 OSSEO RD ~ MPLS, MN 55430 (612) 529-1000 PHONE (612) 588-7660 FAX		REV. A	
PART NAME: MAGNAGLIDE DOOR OPERATOR -VERTICAL		ASSEMBLY NUMBER: MCV1	
DRAWING DATE: 7/3/02			

THIS DOCUMENT CONTAINS INFORMATION WHICH IS PROPRIETARY TO AIRLIFT DOORS. NO REPRODUCTION OR PUBLICATION OF THIS DOCUMENT OR ITS CONTENTS, IN WHOLE OR PART, SHALL BE MADE WITHOUT THE WRITTEN CONSENT FROM AIRLIFT DOORS.

## POWERGLIDE SHOP DRAWING

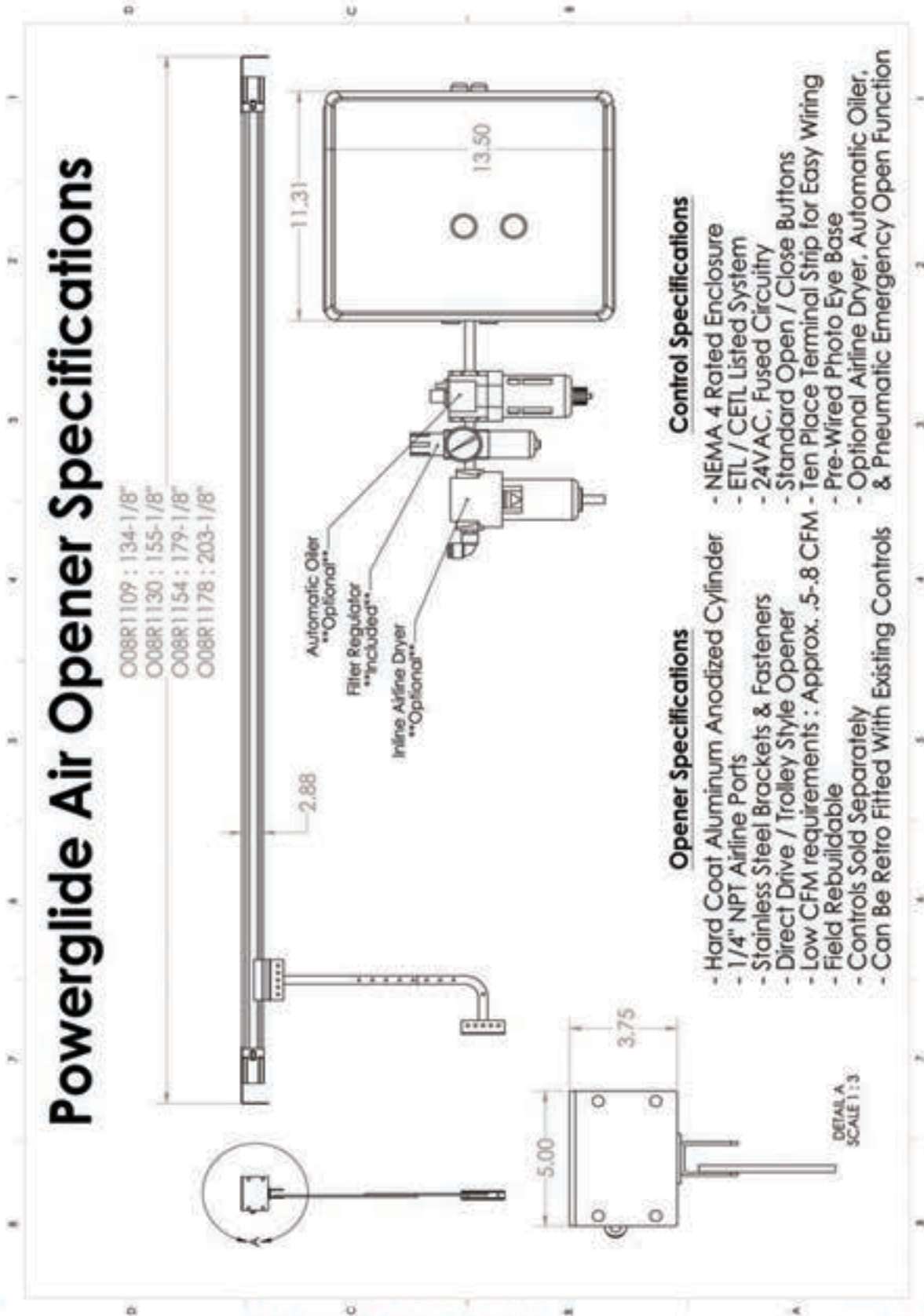





# Product Warranty

# TERMS CONDITIONS

All components of our door packages are covered for a minimum of one year. Please see individual product breakdowns for individual part warranties. No parts will be accepted to the factory as a return without a Return Goods Authorization from Airlift Doors. The RGA # must be written on the outside of the box when returned. No freight or labor will be paid on any warranty parts unless pre-arranged and approved by Airlift Doors, Inc.

## DOOR SECTIONS

Polycarbonate	7 Year
Aluminum Rails	7 Year
End Stile & Center Stile	7 Year
Section Fasteners	7 Year

For questions or to request a return goods authorization, call us toll free at 1-888-368-4403.

## DOOR HARDWARE OPTIONS

Galvanized Hinges	1 Year
Plastic Hinges	5 Year
Stainless Steel Hinges	5 Year
Galvanized Track	1 Year
Plastic Track	5 Year
Stainless Steel Track	7 Year
Galvanized Shaft	1 Year
Stainless Steel Shaft	3 Year
Superglide Bearingless Rollers	5 Year
Superglide Sealed Bearing Rollers	3 Year
Steel Rollers	1 Year

Standard Drum	1 Year
E- Coat Drum	3 Year
Stainless Steel Cable	1 Year
Standard Bearings	1 Year
Stainless Steel Bearings	3 Year
Strapeze Strap	2 Year
Strapeze Counterbalance Parts	2 Year
Strapeze Weights & Hubs	10 Year
Torsion Springs (Or cycle limit)	1 Year

## ORIGINAL AIR OPERATORS

Complete Opener	1 Year
Seals, Caps, & Fittings	1 Year

Tubes, Rods, & Brackets	10 Year
Chain, Sprocket, Turnbuckle	1 Year

## MAGNAGLIDE AIR OPERATORS

Complete MagnaGlide Horizontal	3 Year
Complete MagnaGlide Vertical	3 Year
Pusher Cylinder Kit	1 Year

## POWERGLIDE AIR OPERATORS

Complete Powerglide Operator	3 Year
------------------------------	--------

## CONTROLS & ACCESSORIES

Control Boxes Complete	1 Year
Automatic Valves	1 Year
Parker Valves	1 Year
Valve Coils	7 Year
Air Fittings	1 Year
Photo Eyes Telco	3 Year
Photo Eyes Carlo Gavazzi	3 Year

Filter Regulator	1 Year
Automatic Oiler	1 Year
Inline Dryer	1 Year
All Air Fittings	1 Year
Loops & Loop Detectors	1 Year
Limit Switch	1 Year
Closing Timers	3 Year

## HEATERS

All Heater Components	1 Year	Burner	10 Year
Heater Tubes	5 Year		

## TO ALL CREDIT APPLICANTS:

Thank you for your interest in Airlift Doors, Inc.

We accept Visa, Mastercard, American Express, or Discover credit cards. A net 30 day open account is available once a credit application has been processed. In order to process your application in a timely manner, please be sure to follow the guidelines below. C.O.D. shipments are also available

1. Contact Airlift Doors for a credit application.
2. All business information as well as the social security number of the person responsible for setting up the account must be provided to process the application.
2. Note the amount of credit you want.
3. List three trade references that have allowed you as much credit as you are requesting from us.
4. List at least one bank reference.
5. Be sure to list account, phone, and fax numbers. Without them, your order processing will be delayed.
6. Be sure to include a copy of your Minnesota Certificate of Resale. Without the certificate on file, you will be charged sales tax for any shipments made within Minnesota.
7. Completely fill out the Taxpayer Identification Number Certificate. (W-9) We are required yearly to have a current form on file for all customers.
8. Sign and date the terms of agreement and personal responsibility acknowledgement.

## FIRST TIME CUSTOMERS HAVE THE FOLLOWING OPTIONS:

1. Pay by Visa, Mastercard, American Express or Discover
2. Submit a check for the full amount sent to us prior to shipping or installation
3. C.O.D -- Cash on Delivery. UPS and freight shipments have an additional charge. Charges vary so please consult with Airlift for pricing options when requesting a C.O.D shipment.
4. Freight charges to be freight collect.

Please call with any questions or to check the status of your order.





# Credit Application

# TERMS CONDITIONS

Company Name:

Billing Address:

Shipping Address:

Phone:   
E-Mail:

Fax:   
Web Address:

Circle One:      Sole Proprietorship      Corporation      Partnership

Purchasing Contact:   
Business Type:   
Federal Tax ID #:

Accounts Payable:   
Years In Business:   
Signer's SSN #:

**Trade References:**

#1	#2	#3
<input type="text"/>	<input type="text"/>	<input type="text"/>
<input type="text"/>	<input type="text"/>	<input type="text"/>
<input type="text"/>	<input type="text"/>	<input type="text"/>
<input type="text"/>	<input type="text"/>	<input type="text"/>
<input type="text"/>	<input type="text"/>	<input type="text"/>
<input type="text"/>	<input type="text"/>	<input type="text"/>

**Terms:** All orders are invoiced at the time of shipment. Balance on all orders is due in 30 days, subject to a 1.5% finance charge per month on any unpaid balance over 30 days.

I hereby authorize the above named firms to furnish information requested by Airlift Doors, Inc. to process this application. I also, in my individual capacity (even though I may place a title or other designation next to my signature), unconditionally guarantee and promise to pay to Airlift Doors, Inc. all indebtedness arising from or relating to this application, and any and all collection fees or costs associated with collection of said debt.

Signature: \_\_\_\_\_ Date: \_\_\_\_\_

Print Name: \_\_\_\_\_ Title: \_\_\_\_\_



The following terms are general terms and conditions of sale and shipment. All conditions of sales are subject to change and are valid as determined by the latest terms and conditions printed by Airlift Doors, Inc. (referred to herein after as The Company).

**1. Quotations:** All quotations are only valid if written by an authorized representative of The Company. Written quotations are valid for 30 days unless terminated sooner by notice. Quotations are based solely on information provided by our customers or our interpretation of plans provided. It is the responsibility of the purchaser to verify that the information is correct.

**2. Acceptance of orders:** Orders may be placed through the following means: a) Purchaser may sign a written quote provided by The Company. b) Purchaser may issue a purchase order to The Company with a signature of person verifying the order. c) Orders may be placed verbally if the amount is equal to or less than \$1,000.00. However, it is the responsibility of the purchaser to get a verbal confirmation from The Company deeming the information accurate. All orders must include, at a minimum, the following information: Completed measurement sheet provided by The Company (for all door and operator orders), a detailed description of all products ordered, quantity of items, price, requested delivery date, and shipping instructions. All orders are subject to final acceptance by The Company and are subject to The Company's terms and conditions in effect at the time of acceptance.

**3. Change Orders:** All change orders must be in writing and a signed revised quotation is required for all orders containing a complete door, operator, or heater package.

**4. Terms-Regular:** Terms to purchasers of satisfactory credit are: 30 days net from the date of invoice. Cash discounts, when applicable, are noted on the face of The Company's invoice. All new customers must include credit references with the first order and will be required to send a certified check, money order, or provide a credit card (Visa and Master Card are accepted) before order will be shipped. Finance charges of 1-1/2% will apply per month for all past due invoices. NSF checks will be charged a \$30.00 service fee. We reserve the right to withhold shipments/deliveries should any invoice go beyond our specified terms.

**5. Special Order Product:** All special order product (deemed as any product not stocked by The Company) will require a 50% down payment before any product may be ordered or manufactured by The Company. Special orders are non cancelable and non returnable.

**6. Pricing:** All prices are F.O.B. Factory, (Minneapolis, Maple Lake or Vendor Facility). All prices shown in price lists are list prices in US Dollars and are subject to current discount rates. Customers are responsible for any and all bank charges associated with remitting payment. Prices are subject to change without notice.

**7. Minimum Billing:** Orders amounting to less than \$25.00 will only be accepted if charged to a current credit card.

**8. Shipping Terms:** All shipments are FOB Factory, (Minneapolis, Maple Lake or Vendor Facility). The Company may ship via UPS or common carrier depending on the size and weight of the product. All orders will be assessed a charge for basic commercial packaging. Customers may also request special packaging at an additional charge. Export packaging will be charged at an additional rate based on the requirement and the purchaser is responsible for any applicable export license and all associated costs involved with said license on any export project.

**9. Return Goods:** No product will be accepted without an RGA # authorized by The Company. Warranty returns will be inspected and credited or replaced at the discretion of The Company. Any new items that are returned within 30 days will be accepted with a 15% restocking fee. Purchaser is responsible for cost of shipping and insurance on any products returned. Credits will be issued at the price paid when the product was sold less any shipping charges associated with the return and applicable restocking fee.

**10. Responsibility and Title:** Title in the product shall remain with The Company as security only and until full payment is received by The Company. Risk of loss for the product shall pass to the purchaser upon shipment from F.O.B. point of shipment.

**11. Cancellation of Orders:** Prior to shipment, all orders other than special orders may be cancelled. However, purchaser will be responsible for any engineering, production, packaging, or staging costs involved with the order until the date that The Company is notified in writing of the cancellation.

**12. Freight Damage or Loss:** It is the responsibility of the purchaser to inspect the product received for accurate piece counts or any visible damage. In case of damage or shortage, the purchaser should note the information on the bill of lading and immediately file a claim with the shipping company.

**13. Warranty:** See individual product warranties. The Company will assume no responsibility for any labor charges unless agreed upon in writing in advance. The Company's liability with respect to this agreement or the sale of the product shall be limited to the amount paid by the purchaser for the products.

**14. Force Majeure:** The Company shall not be liable for any delays in shipment or damage to product caused by fire, flood, accident, riots, sabotage, governmental interference, strikes, or any other causes beyond The Company's control.

**15. Lead Times:** General lead times for stock items are as follows: 1) Parts orders may ship same day if received by The Company before 2:00 P.M. Central Time. Next Day Air or other rush services are available upon the request of the purchaser for additional charges. 2) Door and operator packages typically will ship within 1-2 weeks of receipt of the order and measurement form. Rush orders constitute anything under a week and may require an additional 5% fee depending on current shipping schedules.

**16. Laws of Minnesota:** The Customer agrees that all transactions between the Company and the Customer will be governed by the laws of the State of Minnesota and any dispute arising from this relationship will be litigated exclusively in state court in Hennepin County, State of Minnesota. The Customer consents to the jurisdiction of Minnesota court. In the event that it becomes necessary for the Company to institute suit or otherwise incur collection costs to collect any amount due by to the Company by the Customer, the Customer agrees to pay those costs of collection, including reasonable attorneys fees.



# **GUARANTEED - (GUAR·AN·TEED)**

**VERB -**

**ATTESTS TO THE QUALITY OR DURABILITY  
OF A PRODUCT OR SERVICE.**

**GUARANTEED** quality in our products.  
**GUARANTEED** that we stand behind our warranties.  
**GUARANTEED** shortest lead times in the industry  
on all standard size doors and openers.



**AIRLIFT DOORS, INC.**

Contact our experienced sales team today  
and see what Airlift Doors, Inc can offer you!

**1-888-368-4403    [www.AirliftDoors.com](http://www.AirliftDoors.com)**





**AIRLIFT DOORS, INC.**

**[www.AirliftDoors.com](http://www.AirliftDoors.com)**

Email: [sales@airliftdoors.com](mailto:sales@airliftdoors.com)

Toll Free: 1-888-368-4403

Fax: 612-588-7660

*For more information  
on our other products  
and catalogs, please call  
or visit our website!*

