

P90 SPECIFICATION SHEET (WITH PERMA PLEATS AND F HEADER)

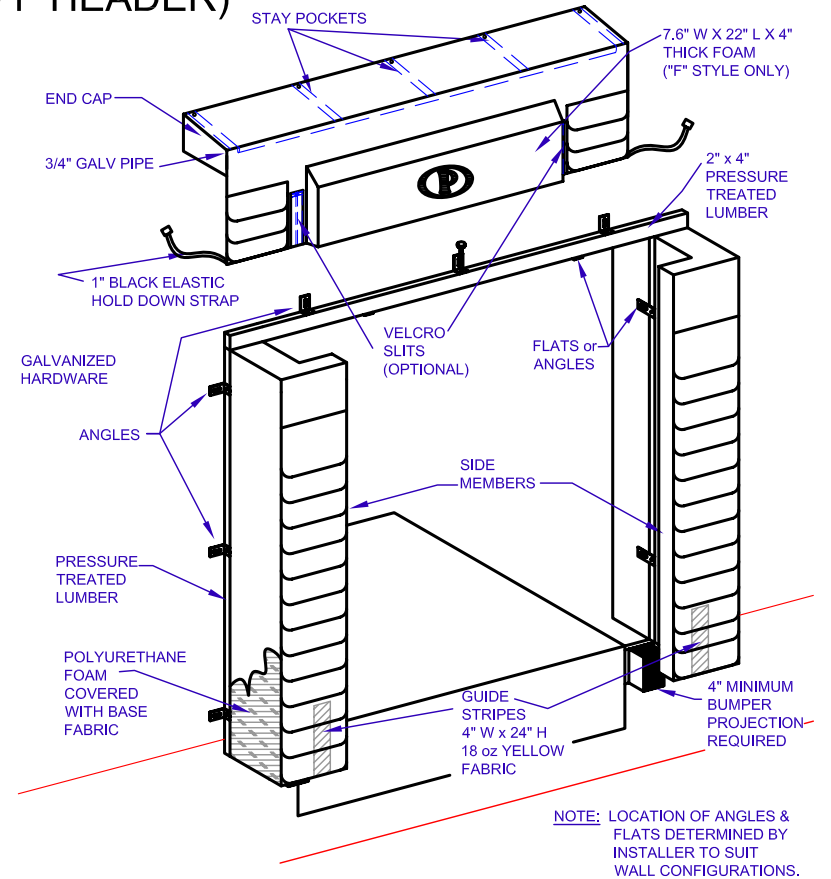

SIDE PAD MOUNTING VARIATIONS: CIRCLE ONE

Enter Side Pad Face Width:

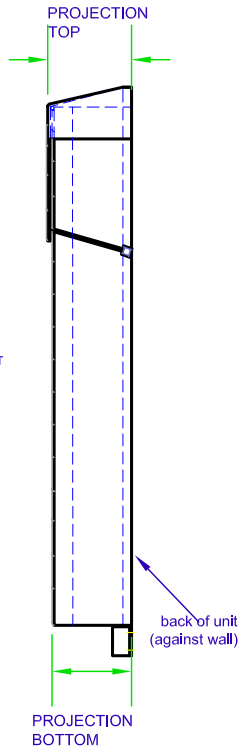
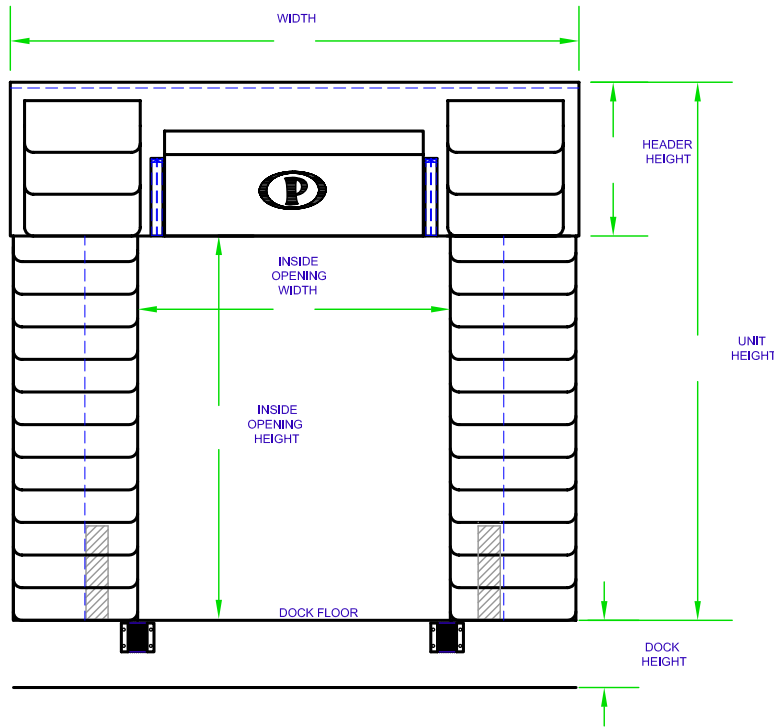
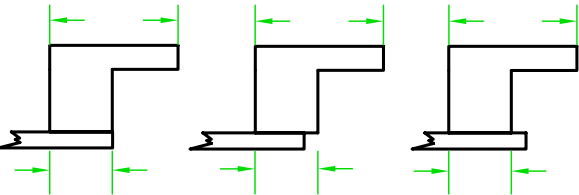

Enter Side Pad Base Width:

NOSE WRAP (SAME AS PLEAT FABRIC)

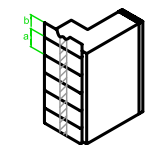
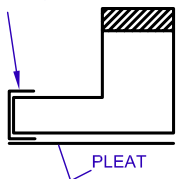

PP4
a. Exposure 4"
b. Overlap 4"

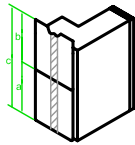

PP8
a. Exposure 8"
b. Overlap 10"
c. Total Length 18"

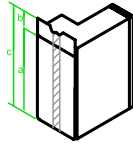

PP16
a. Exposure 16"
b. Overlap 2"
c. Total Length 18"

QUANTITY: _____, MODEL: _____
 UNIT SIZE: _____ WIDTH, _____ HEIGHT
 HEAD CURTAIN: _____ WIDTH, _____ DROP
 INSIDE OPENING WIDTH: _____
 INSIDE OPENING HEIGHT: _____
 PROJECTION: _____ TOP, _____ BOTTOM
 SIDE PAD: _____ HEIGHT, _____ WEDGE
 CHAIN FLAP: _____ WIDTH, _____ LENGTH
 BASE FABRIC: _____, COLOR: _____
 FACE FABRIC: _____, COLOR: _____

DOOR SIZE: _____ WIDTH, _____ HEIGHT
 DOCK HEIGHT: _____, BUMPER PROJECTION: _____
 APPROACH: LEVEL DECLINE INCLINE
 _____" DIFFERENCE IN 50'-0"

OPTIONS:
 VELCRO SLIT: _____ HEIGHT.
 3 ROPE PULL-UP
 UNIT SUPPORT FRAME: WOOD STEEL
 INSIDE WRAP -
 MATERIAL: _____, HEIGHT: _____

SPECIAL INFORMATION



PERMA TECH, INC.

363 HAMBURG STREET • BUFFALO, NY 14204
 (716) 854-0707 • 1-800-DOC-SEAL
www.permatechinc.com

JOB: _____

DEALER: _____

CONTACT: _____ QUOTE #: _____

APPROVED BY SIGNATURE: _____