

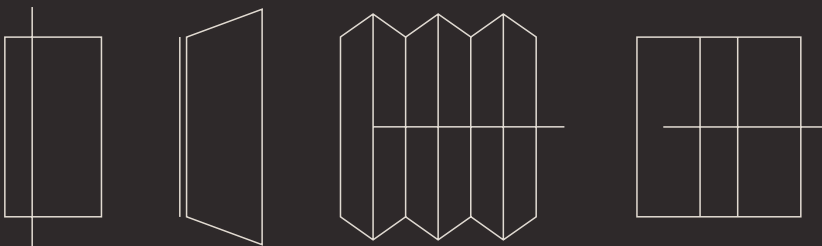

# Veris<sup>™</sup>

COLLECTION

Open to  
possibilities.











# Experience open-air living with the Veris™ collection.

Blur the lines between home and the outdoors with expansive glass and sleek minimalist designs. This exclusive collection pairs high-end style with unique functionality – all from the entry door brand building professionals choose most.\*

## Confidence in a complete system.

With the Veris collection, each piece is engineered to work together seamlessly for easy, worry-free operation backed by comprehensive warranties for peace of mind.

Visit [VerisCollection.com](http://VerisCollection.com) for details on limited warranties and exclusions.

**LIFETIME**  
LIMITED  
WARRANTY  
TRANSFERABLE

Door System

**10 YEAR**  
LIMITED  
WARRANTY  
TRANSFERABLE

Finish

\*Brand Use Study, 2022 *Builder* magazine.

## TABLE OF CONTENTS

Movement with Purpose	4-5
Pivot Entry Doors	6-17
Hinged Glass Doors	18-29
Folding Glass Doors	30-41
Sliding Glass Doors	42-53
Structural & Impact-Rated Options	54-55

# Movement with Purpose

Explore a variety of operational methods to connect with the outdoors through expansive glass panels that easily glide open and shut.



## Pivot Entry Doors

The epitome of modern style with unique movement. Features a pivot point at the top and bottom of the door instead of along the edge.

More on pages 6–17.



## Hinged Glass Doors

Ideal for homes with contemporary styling. Available in single and french door configurations for a simplistic look in the front or back of the home.

More on pages 18–29.





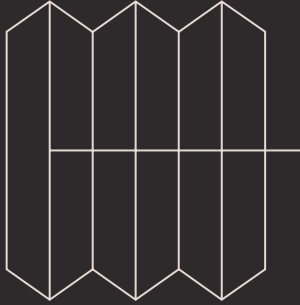

## Folding Glass Doors

Perfect for connecting indoor and outdoor spaces in homes with patios, decks, enclosed porches and more. Optional swing door allows for easy entry or exit without opening all the panels.

More on pages 30–41.

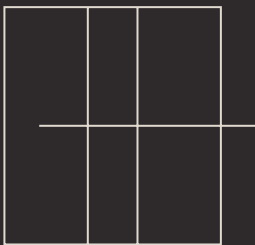

## Sliding Glass Doors

Enjoy expansive views and easy access to outdoor living spaces. Optional pocket door construction can deliver completely unobstructed views when fully opened.

More on pages 42–53.



# Pivot Entry Doors







---

## Unique style and movement.

Discover the epitome of modern style with unique movement with Veris pivot entry doors. Experience the smooth pivoting motion, sleek style and expansive glass that make them the perfect choice for any contemporary entryway.

# Confidence in a Complete System

Create the ultimate open-air living experience with superior performance thanks to our full-system approach. With the Veris™ collection, each piece is engineered to work together seamlessly.

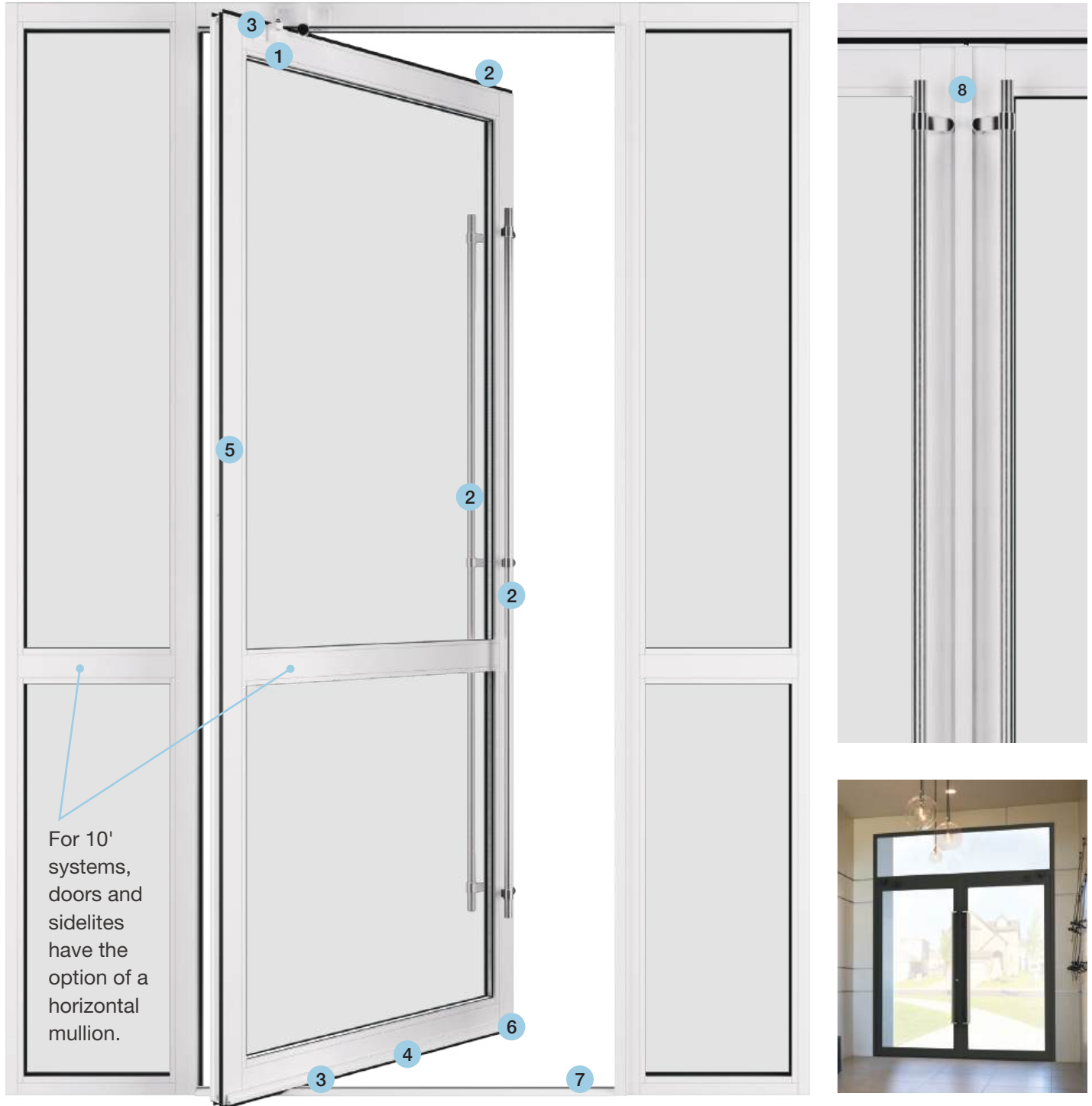

Shown from the exterior side of the door system.

\*French door systems and 10' door systems will include flush bolts.

\*\*Door systems built with a flush sill have little resistance to water penetration and have a potential to leak if installed exposed to weather. We recommend these systems be installed away from weather under large soffits or overhangs. For ADA compliance, the door must provide a minimum 32" clear opening width.

Verify all other ADA compliance requirements with your local building code official.



Component images shown from interior side of the door system.



A **door catch** holds the door open while blending into the system. A rubber stopper provides quiet operation.



In addition to the **deadbolt**, the **flush bolt\*** offers another locking point and is integrated into single and french configurations for added security and enhanced performance in severe weather.

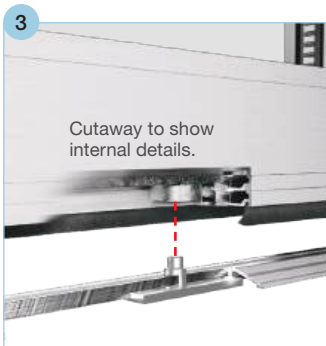

**Pivot hardware** delivers the innovative movement of the pivot door with a **sealed bearing** on the bottom for smooth, quiet operation.

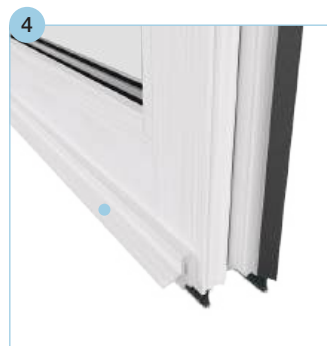
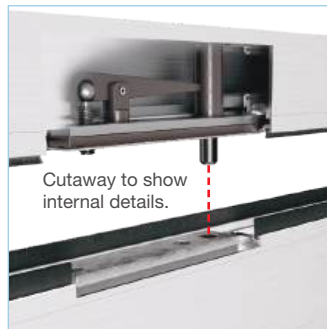

Built-in **rain deflector** helps protect areas exposed to wind-driven rain, enhancing weather protection.

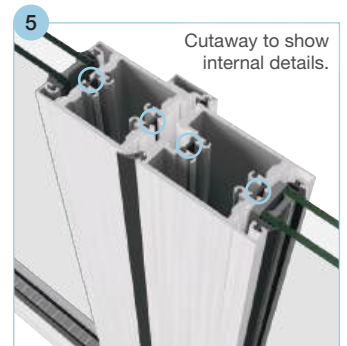

**Thermal break design** separates interior and exterior aluminum to reduce heat and cold transfer between indoors and outdoors which helps reduce condensation.

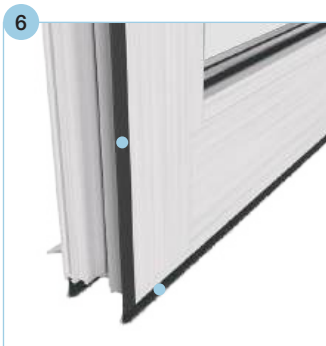

Designed to provide the best possible fit between panel and frame, the **weatherstrip** helps prevent water and air from entering the home.



**Thermally broken sills** reduce the transfer of heat and cold through the door system for greater energy efficiency while reducing condensation buildup. Available in a flush configuration for ADA compliance.\*\*



As part of french door configurations, an **astragal** is integrated into the unit to assist with sealing the door system for better protection from the elements.

# V-2 vs. V-3



**V-2 Systems:  
Built for everyday life.**

Our V-2 systems are designed to meet the needs for most homes and structures. Featuring our standard components that are quality tested for long-term use, the V-2 system is perfect for residential dwellings in most areas of the United States.

**Panel & System Thickness: 2-1/4"**

**Maximum Height: 8'**



**V-3 Systems:  
Performance where you need it.**

Our V-3 systems are engineered to meet the high-performance needs of specific regions, building codes and commercial structures, and are built to support larger glass panels found in our taller units. With high-performance components that can stand up to heavy-duty use, the V-3 system is ideal for structures and door units that require extra support and stability.

**Panel & System Thickness: 3"**

**Maximum Height: 10'**

## Size Offering

Pivot configurations with a door that exceeds 8'0" in height or a transom that exceeds 8'0" in width will be built as a V-3 system.

Doors		Single & French			
Panel Width		3'6"	4'0"	5'0"	6'0"
Height	6'8"				
	7'0"				
	8'0"				
	9'0"				
	10'0"				

Sidelites					
Width		14"	18"	20"	24"
Height	6'8"				
	7'0"				
	8'0"				
	9'0"				
	10'0"				

Transoms		Single & Single w/One Sidelite				Single w/Two Sidelites				French			French w/Two Sidelites		
Panel Width		3'6"	4'0"	5'0"	6'0"	3'6"	4'0"	5'0"	6'0"	3'6"	4'0"	5'0"	3'6"	4'0"	5'0"
Height	14"														
	18"														
	20"														
	24"														

- Standard Lead Time
- Extended Lead Time



# Configurations

Shown from the exterior side of the door system.

Available as inswing or outswing.



Single

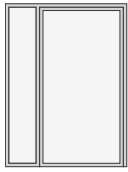

Single with Left Sidelite

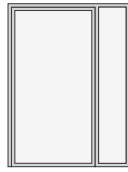

Single with Right Sidelite

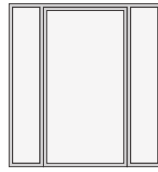

Single with Two Sidelites

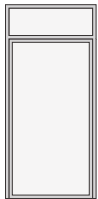

Single with Transom

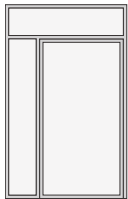

Single with Left Sidelite and Transom

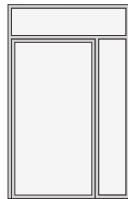

Single with Right Sidelite and Transom

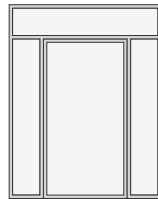

Single with Two Sidelites and Transom

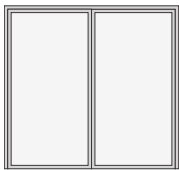

French

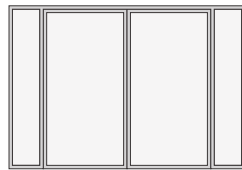

French with Two Sidelites

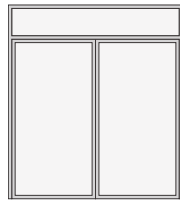

French with Transom

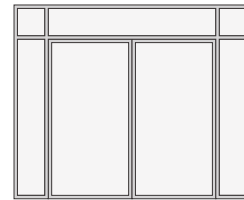

French with Two Sidelites and Transoms



# Glass Options



### Enhanced Low-E

Blocks 95% of the sun's harmful UV rays, helping to preserve the color and materials of your interior furnishings, draperies and wall treatments.\*



### Low-E

Delivers exceptional energy efficiency, retaining heat in the winter and reflecting it in the summer.



### Turtle with Low-E

Tinted gray to reduce interior light projection as required near sea turtle nesting areas. Includes Low-E coating for exceptional energy efficiency.

## Optional Neat+™ Coating

All Low-E glass in the Veris collection is available with Neat+ coating. This low-maintenance coating is designed to help keep glass clear and free of watermarks, reducing the need for cleaning.\*



Without  
Neat+ Coating

With  
Neat+ Coating



\*For more information on enhanced Low-E glass and Neat+ coating, visit [www.solarinnovations.com](http://www.solarinnovations.com).



## Divided Lites

Not available for 10' units.

### Available Patterns

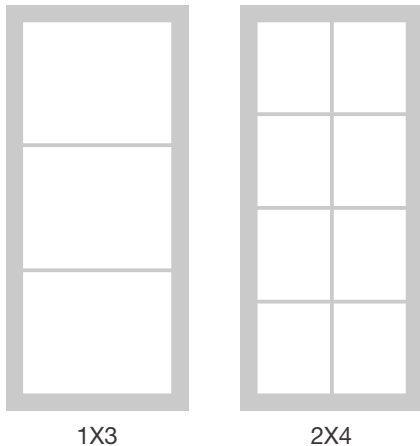

1X3

2X4

### Grilles Between Glass (GBGs)



GBGs are sealed between two panes of tempered glass for a smooth easy-to-clean surface.

Height: 5/8"

Depth: 3/16"

### Finish Options for GBGs

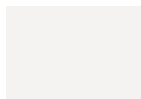

White



Black

Split finish not available for GBGs.

### Simulated Divided Lites (SDLs) with Grilles Between Glass (GBGs)

SDLs are adhered to the interior and exterior panes of tempered glass and are finished to complement the door system. For a more authentic divided lite look, SDLs are layered over black GBGs.



Traditional Profile

Height: 3/4"

Depth: 15/32"



Flat Profile

Height: 3/4"

Depth: 5/32"

## Configurations with SDL / GBG Patterns

### 1X3

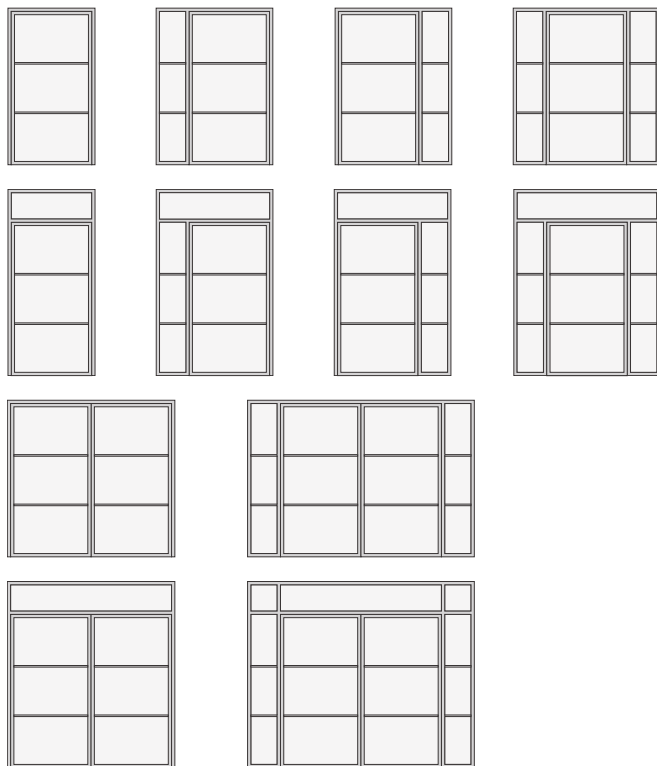

### 2X4

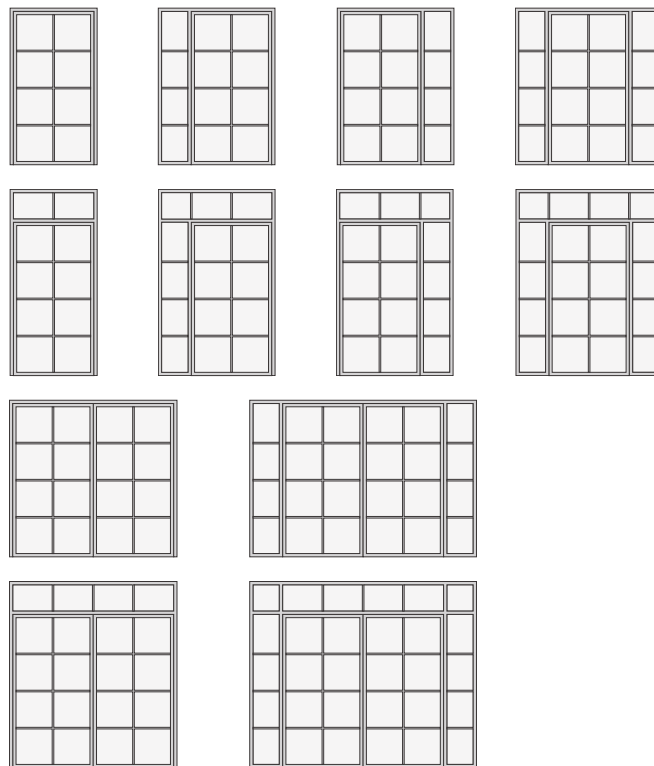

# Finish

Choose from an on-trend assortment of finishes designed to complement most homes.

## Standard Lead Powder Coated

Similar to semi-gloss finish.

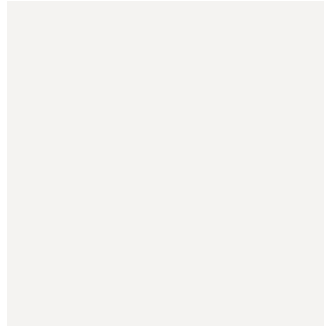

White

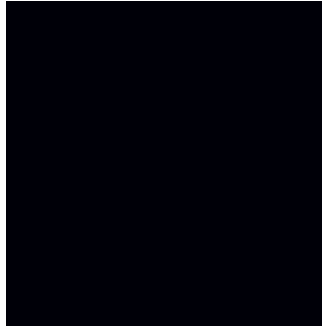

Black

## Standard Lead Anodized

Similar to eggshell finish.



Clear

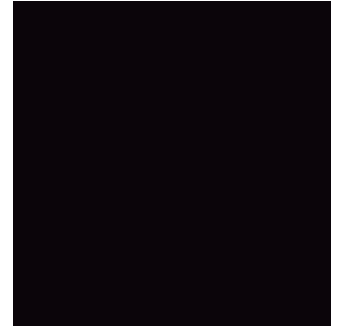

Dark Bronze

## Extended Lead Powder Coated

Similar to semi-gloss finish.

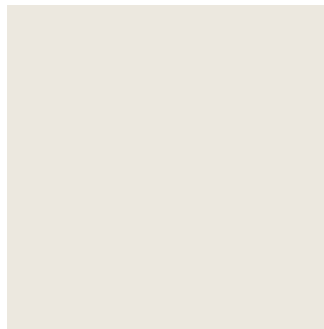

Bone White



Sandstone



Fashion Gray

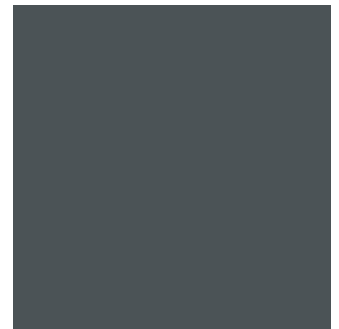

Charcoal



White / Black

### Additional Split Finish Options

Choose any two colors to create a split finish that complements the interior and exterior of the home. Available on extended lead time.

Order 3-1/8" x 4" samples of finish colors at [store.thermatru.com](http://store.thermatru.com).

## Sills



Flush Sill (ADA)\*

### Sill Finish Options

- Clear Anodized
- Dark Bronze Anodized

\*Door systems built with a flush sill have little resistance to water penetration and have a potential to leak if installed exposed to weather. We recommend these systems be installed away from weather under large soffits or overhangs. For ADA compliance, the door must provide a minimum 32" clear opening width. Verify all other ADA compliance requirements with your local building code official.

Note: Finish colors may vary from an actual application due to fluctuations in finishing or printing. See your Therma-Tru seller for details on the Veris collection limited finish warranty and exclusions.



# Handlesets

Active handlesets come standard with thumbturn interior lock with keyed exterior.

The multi-point locking system engages the panel and frame at three points for enhanced security while helping to preserve the compression seal's hold, even under the pressure of high winds.

Inspira and Verge handlesets deliver the minimalist style of a modern door pull. The handles are partially offset from the rail for comfortable access to the lock. The lock features an interior thumbturn and exterior keyed options. French door systems and 10' door systems will also include flush bolts.

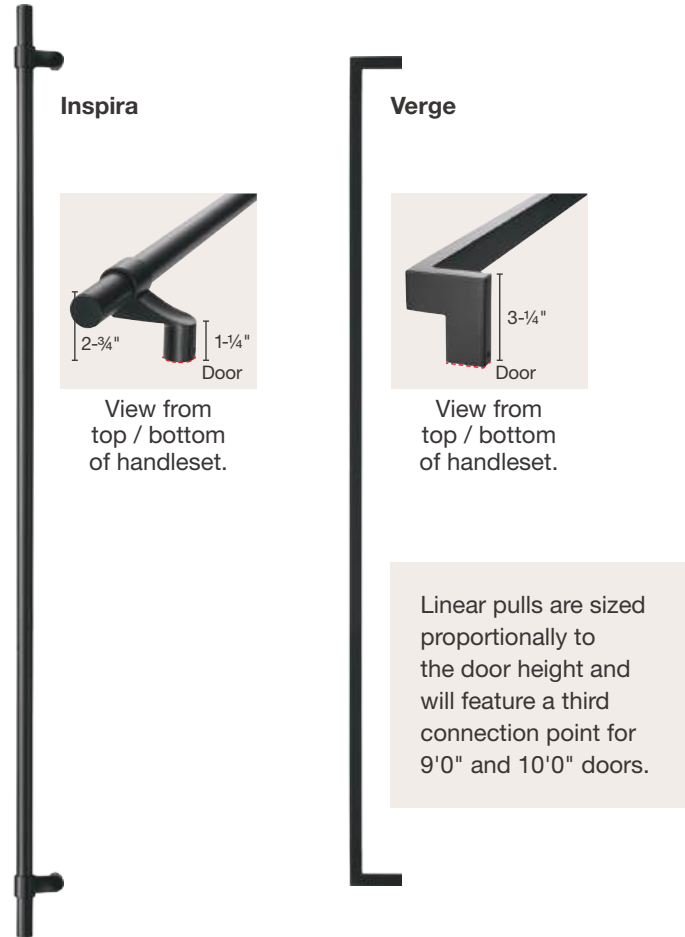

## Handleset Finish Options

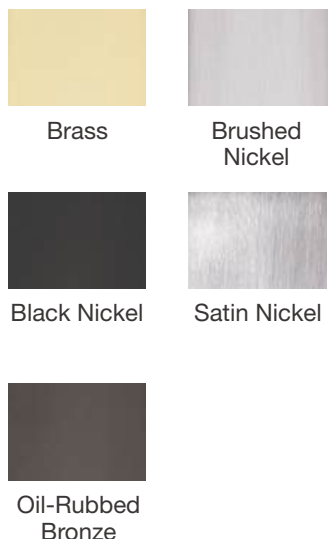

## Availability

	Brass	Brushed Nickel	Black Nickel	Satin Nickel	Oil-Rubbed Bronze
<b>Heirloom</b>	Standard Lead Time	Standard Lead Time	Standard Lead Time	Standard Lead Time	Standard Lead Time
<b>Venture</b>	Standard Lead Time	Standard Lead Time	Standard Lead Time	Standard Lead Time	Standard Lead Time
<b>Millennium</b>	Standard Lead Time	Standard Lead Time	Standard Lead Time	Standard Lead Time	Standard Lead Time
<b>Realm</b>	Standard Lead Time	Standard Lead Time	Standard Lead Time	Standard Lead Time	Standard Lead Time
<b>Inspira</b>	Not Available	Not Available	Not Available	Extended Lead Time	Not Available
<b>Verge</b>	Not Available	Not Available	Not Available	Extended Lead Time	Not Available

Standard Lead Time
  Extended Lead Time
  Not Available

# V-2 Details

 **Thermal Break** Veris glass door systems feature thermal breaks, shown here in red.

## Sill

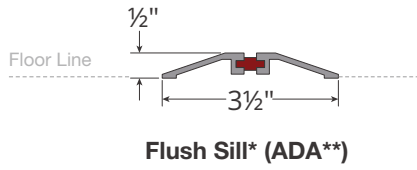

## Vertical & Horizontal Rail

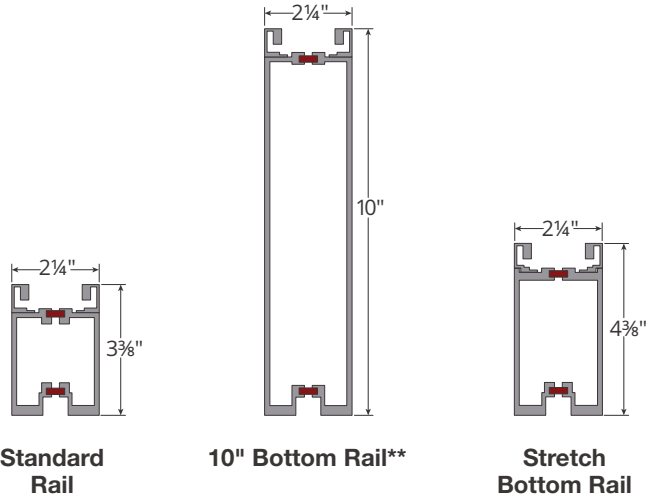

\*Door systems built with a flush sill have little resistance to water penetration and have a potential to leak if installed exposed to weather. We recommend these systems be installed away from weather under large soffits or overhangs.  
 \*\*For ADA compliance, the door must provide a minimum 32" clear opening width. Verify all other ADA compliance requirements with your local building code official.



# V-3 Details

## Sill

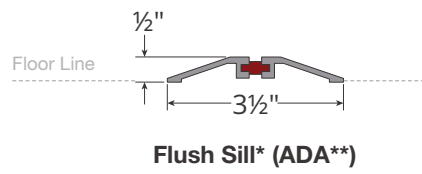

## Vertical & Horizontal Rails

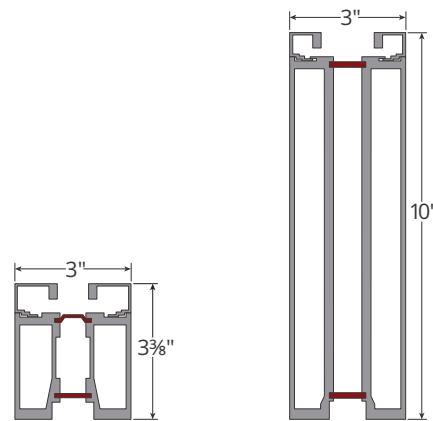

**Standard Rail**

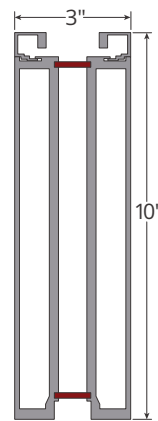

**10" Bottom Rail\*\***

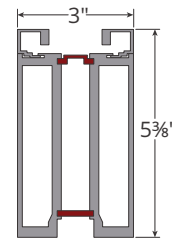

**Stretch Bottom Rail**



Scan to learn more.

**THERMA TRU**  
DOORS





# Hinged Glass Doors





---

## Simplistic styling with a contemporary look.

Discover a transitional design with contemporary appeal. Veris hinged door systems welcome an abundance of natural light into the home through the simplicity of glass. Find single and french door configurations designed to complement a wide range of home styles.

# Confidence in a Complete System

Create the ultimate open-air living experience with superior performance thanks to our full-system approach. With the Veris™ collection, each piece is engineered to work together seamlessly.

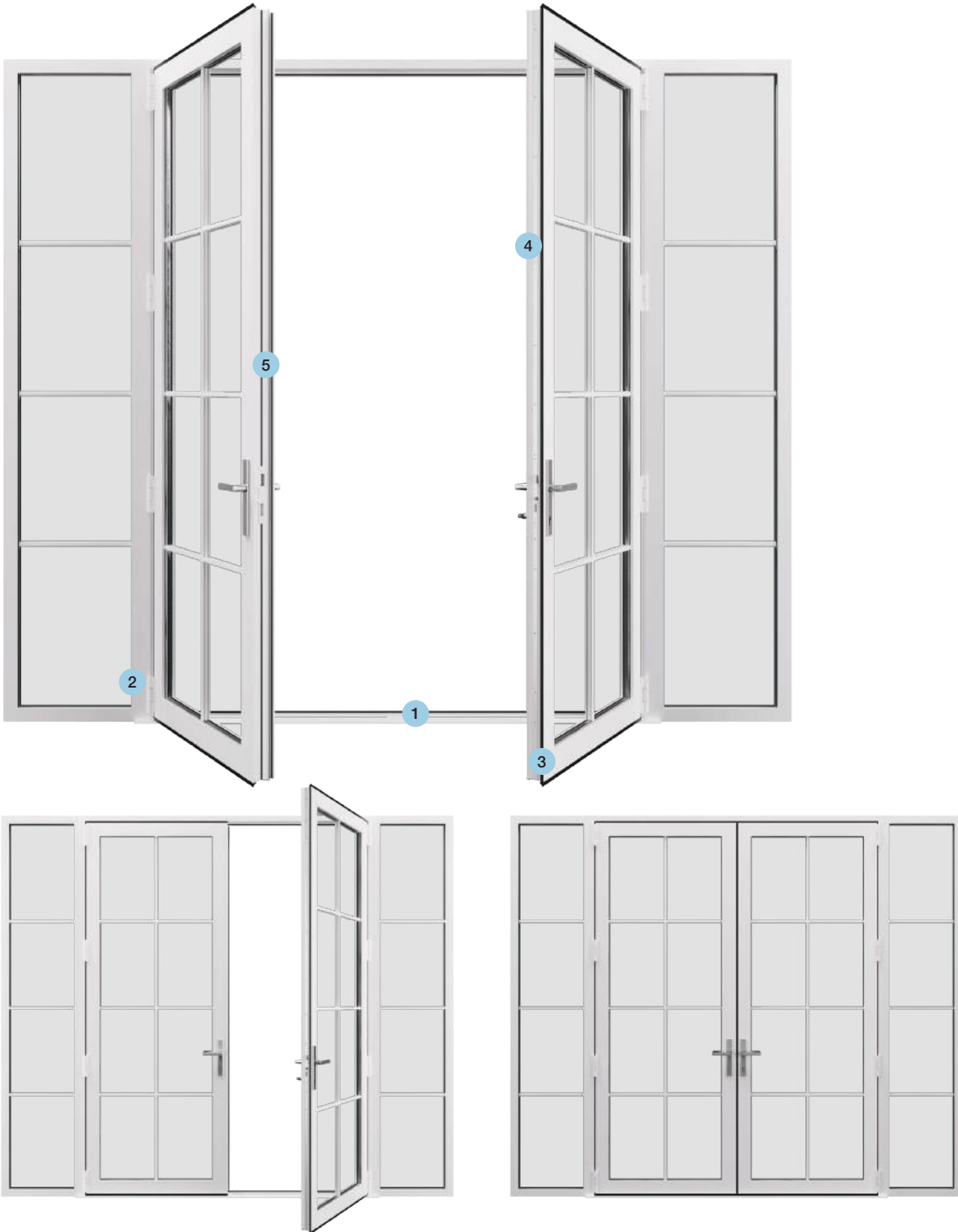

\*Door systems built with a flush sill have little resistance to water penetration and have a potential to leak if installed exposed to weather. We recommend these systems be installed away from weather under large soffits or overhangs.





Standard Inswing



Standard Outswing



Flush\*

**Thermally broken sills** reduce the transfer of heat and cold through the door system for greater energy efficiency while reducing condensation buildup.

Sills are available in **standard** for water performance and **flush** for ADA compliance.\*\*



**Semi-concealed hinges** built into the panels blend with the door system. Manufactured in-house to high tolerances under tight quality control. Color match options are available.



Designed to provide the best possible fit between panel and frame, the **weatherstrip** helps prevent water and air from entering the home.



**Thermal break design** separates interior and exterior aluminum to reduce heat and cold transfer between indoors and outdoors which helps reduce condensation.



As part of french door configurations, an **astragal** is integrated into the unit to assist with sealing the door system for better protection from the elements.

**THERMA TRU**  
DOORS



# V-2 vs. V-3



**V-2 Systems:  
Built for everyday life.**

Our V-2 systems are designed to meet the needs for most homes and structures. Featuring our standard components that are quality tested for long-term use, the V-2 system is perfect for residential dwellings in most areas of the United States.

**Panel & System Thickness: 2-1/4"**

**Maximum Height: 8'**



**V-3 Systems:  
Performance where you need it.**

Our V-3 systems are engineered to meet the high-performance needs of specific regions, building codes and commercial structures, and are built to support larger glass panels found in our taller units. With high-performance components that can stand up to heavy-duty use, the V-3 system is ideal for structures and door units that require extra support and stability.

**Panel & System Thickness: 3"**

**Maximum Height: 10'**

## Size Offering

Hinged configurations with a door that exceeds 8'0" in height or a transom that exceeds 8'0" in width will be built as a V-3 system.

Doors		Single						French					
Panel Width		2'6"	2'8"	2'10"	3'0"	3'6"	4'0"	2'6"	2'8"	2'10"	3'0"	3'6"	4'0"
Height	6'8"												
	7'0"												
	8'0"												
	9'0"												
	10'0"												

Sidelites		Single with or without Sidelite(s)			
Width		14"	18"	20"	24"
Height	6'8"				
	7'0"				
	8'0"				
	9'0"				
	10'0"				

Transoms		Single with or without Sidelite(s)					
Panel Width		2'6"	2'8"	2'10"	3'0"	3'6"	4'0"
Height	14"						
	18"						
	20"						
	24"						

Transoms		French						French with Two Sidelites					
Panel Width		2'6"	2'8"	2'10"	3'0"	3'6"	4'0"	2'6"	2'8"	2'10"	3'0"	3'6"	4'0"
Height	14"												
	18"												
	20"												
	24"												

Standard Lead Time
  Extended Lead Time

# Configurations

Shown from the exterior side of the door system. See page 54 for structural and Impact-rated options.

Available as inswing or outswing.



Single

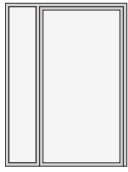

Single with  
Left Sidelite

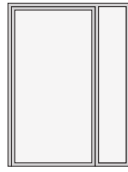

Single with  
Right Sidelite

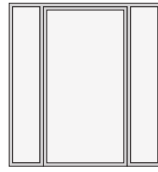

Single with  
Two Sidelites



Single with  
Transom

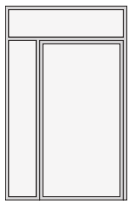

Single with  
Left Sidelite  
and Transom

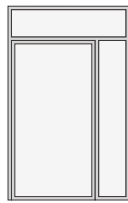

Single with  
Right Sidelite  
and Transom

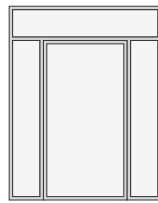

Single with  
Two Sidelites  
and Transom

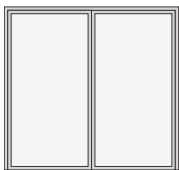

French

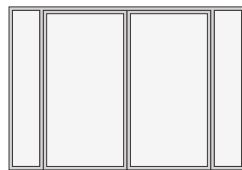

French with  
Two Sidelites

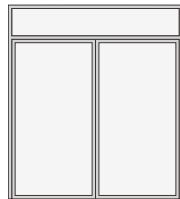

French with  
Transom

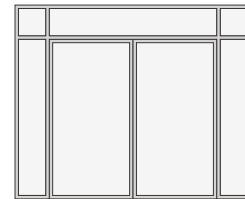

French with  
Two Sidelites and  
Transoms

**THERMA TRU**  
DOORS





## Glass Options



### Enhanced Low-E

Blocks 95% of the sun's harmful UV rays, helping to preserve the color and materials of your interior furnishings, draperies and wall treatments.\*



### Low-E

Delivers exceptional energy efficiency, retaining heat in the winter and reflecting it in the summer.



### Turtle with Low-E

Tinted gray to reduce interior light projection as required near sea turtle nesting areas. Includes Low-E coating for exceptional energy efficiency.

## Optional Neat+™ Coating

All Low-E glass in the Veris collection is available with Neat+ coating. This low-maintenance coating is designed to help keep glass clear and free of watermarks, reducing the need for cleaning.\*



Without  
Neat+ Coating

With  
Neat+ Coating



## Divided Lites

### Available Patterns

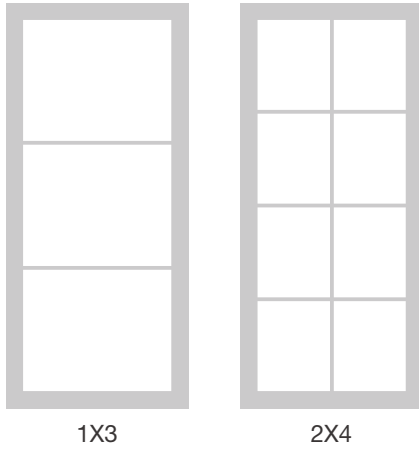

1X3

2X4

### Grilles Between Glass (GBGs)



GBGs are sealed between two panes of tempered glass for a smooth easy-to-clean surface.

Height:  $\frac{5}{8}$ "  
Depth:  $\frac{3}{16}$ "

### Finish Options for GBGs

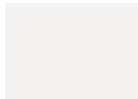

White



Black

Split finish not available for GBGs.

### Simulated Divided Lites (SDLs) with Grilles Between Glass (GBGs)

SDLs are adhered to the interior and exterior panes of tempered glass and are finished to complement the door system. For a more authentic divided lite look, SDLs are layered over black GBGs.



Traditional Profile

Height:  $\frac{3}{4}$ "  
Depth:  $\frac{15}{32}$ "

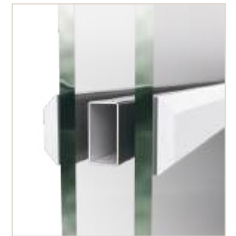

Flat Profile

Height:  $\frac{3}{4}$ "  
Depth:  $\frac{5}{32}$ "

## Configurations with SDL / GBG Patterns

### 1X3

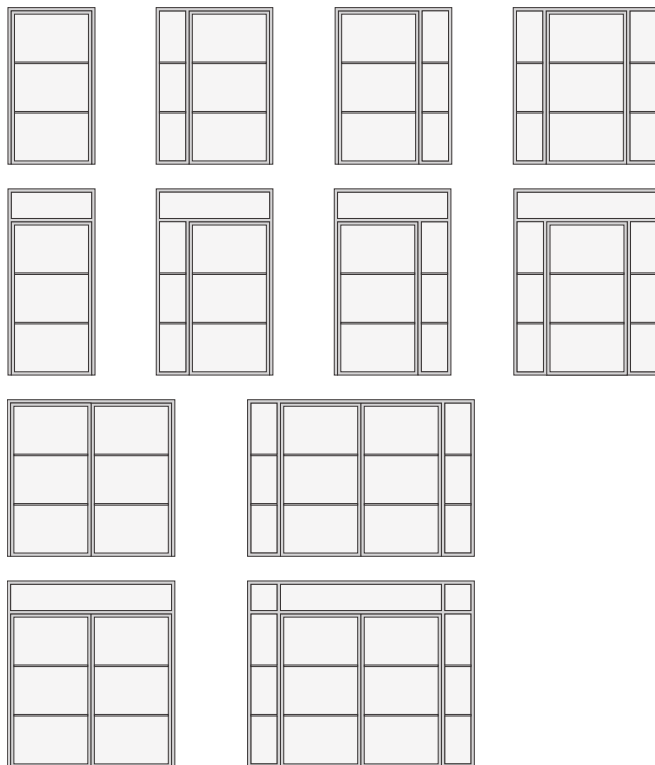

### 2X4

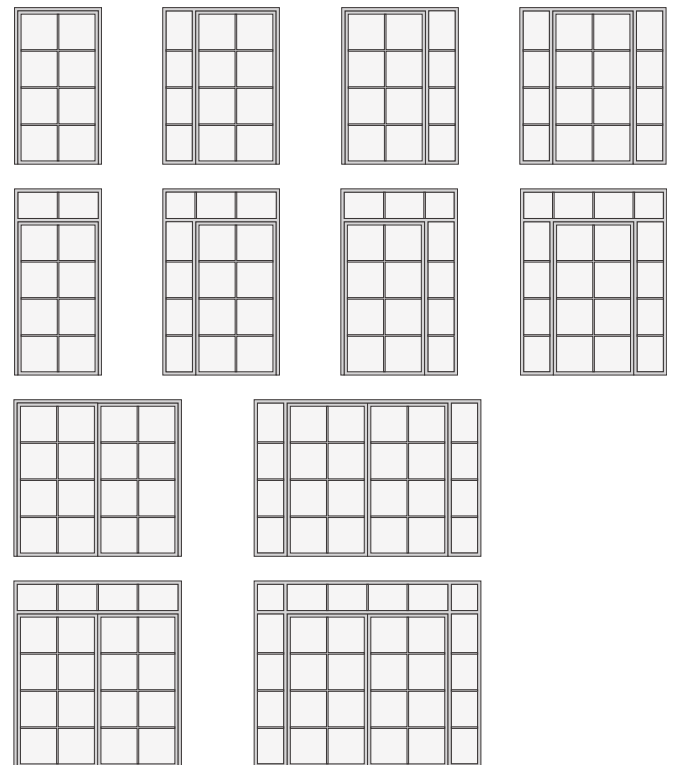

# Finish

Choose from an on-trend assortment of finishes designed to complement most homes.

## Standard Lead Powder Coated

Similar to semi-gloss finish.

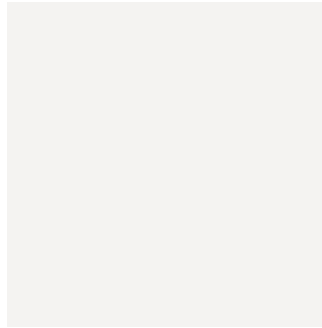

White



Black

## Standard Lead Anodized

Similar to eggshell finish.



Clear

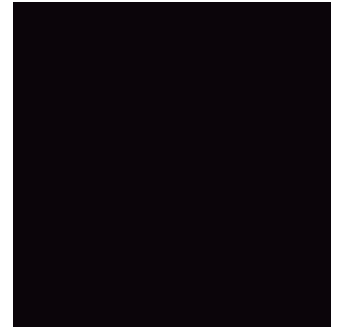

Dark Bronze

## Extended Lead Powder Coated

Similar to semi-gloss finish.

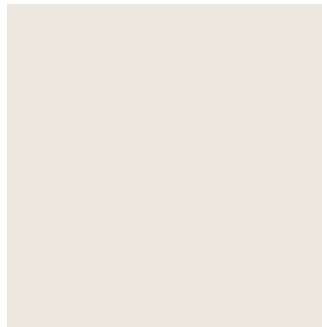

Bone White

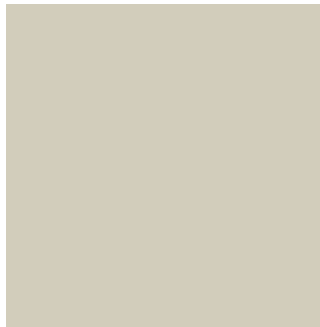

Sandstone



Fashion Gray



Charcoal



White / Black

### Additional Split Finish Options

Choose any two colors to create a split finish that complements the interior and exterior of the home. Available on extended lead time.

Order 3-1/8" x 4" samples of finish colors at [store.thermatru.com](http://store.thermatru.com).

# Sills



Flush Sill\* (ADA)



Standard Sill Inswing



Standard Sill Outswing

### Sill Finish Options

- Clear Anodized
- Dark Bronze Anodized

\*Door systems built with a flush sill have little resistance to water penetration and have a potential to leak if installed exposed to weather. We recommend these systems be installed away from weather under large soffits or overhangs. For ADA compliance, the door must provide a minimum 32" clear opening width. Verify all other ADA compliance requirements with your local building code official.

Note: Finish colors may vary from an actual application due to fluctuations in finishing or printing. See your Thermo-Tru seller for details on the Veris collection limited finish warranty and exclusions.



# Handlesets

Active handlesets come standard with thumbturn interior lock with keyed exterior.

The multi-point locking system engages the panel and frame at three points for enhanced security while helping to preserve the compression seal's hold, even under the pressure of high winds.

Inspira and Verge handlesets deliver the minimalist style of a modern door pull. The handles are partially offset from the rail for comfortable access to the lock. The lock features an interior thumbturn and exterior keyed options. French door systems and 10' door systems will also include flush bolts.

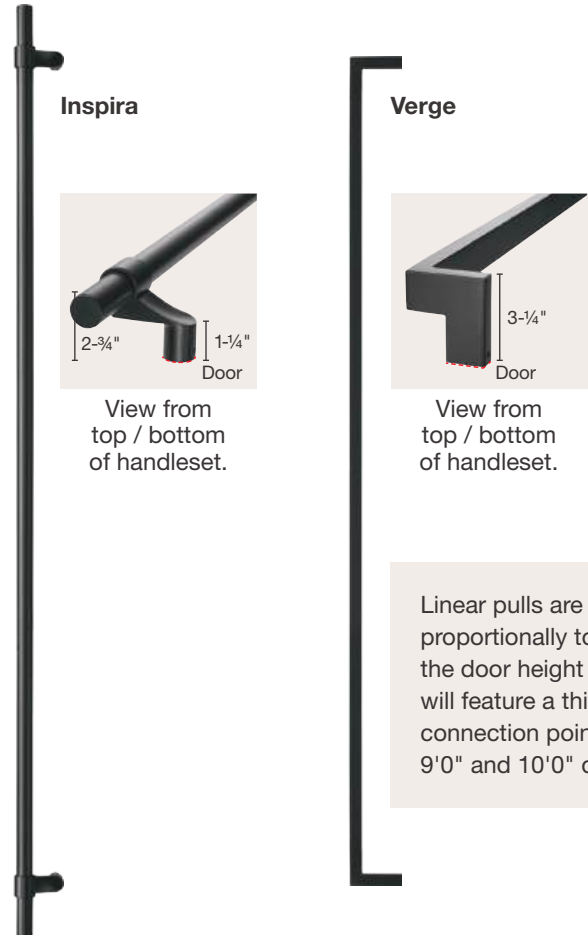

## Handleset Finish Options

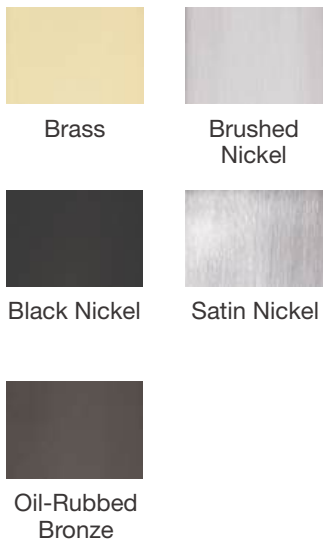

## Availability

	Brass	Brushed Nickel	Black Nickel	Satin Nickel	Oil-Rubbed Bronze
Heirloom	Standard Lead Time	Standard Lead Time	Standard Lead Time	Standard Lead Time	Standard Lead Time
Venture	Standard Lead Time	Standard Lead Time	Standard Lead Time	Standard Lead Time	Standard Lead Time
Millennium	Standard Lead Time	Standard Lead Time	Standard Lead Time	Standard Lead Time	Standard Lead Time
Realm	Standard Lead Time	Standard Lead Time	Standard Lead Time	Standard Lead Time	Standard Lead Time
Inspira	Standard Lead Time	Standard Lead Time	Standard Lead Time	Extended Lead Time	Standard Lead Time
Verge	Standard Lead Time	Standard Lead Time	Standard Lead Time	Extended Lead Time	Standard Lead Time

Standard Lead Time
  Extended Lead Time
  Not Available

# V-2 Details

**Thermal Break** Veris glass door systems feature thermal breaks, shown here in red.

## Sills

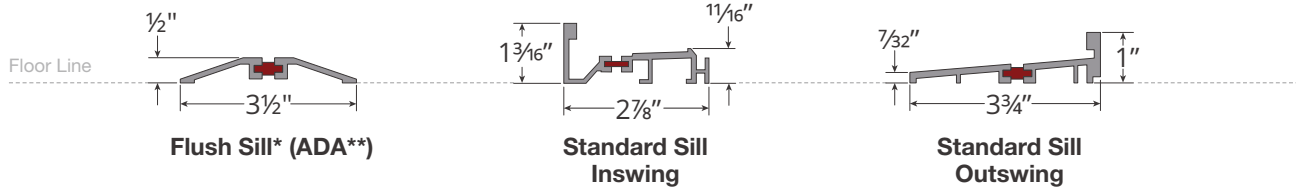

## Vertical & Horizontal Rails

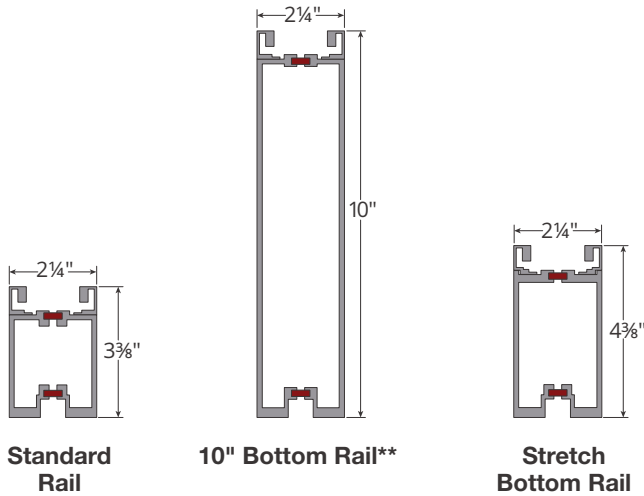

\*Door systems built with a flush sill have little resistance to water penetration and have a potential to leak if installed exposed to weather. We recommend these systems be installed away from weather under large soffits or overhangs.  
 \*\*For ADA compliance, the door must provide a minimum 32" clear opening width. Verify all other ADA compliance requirements with your local building code official.





# V-3 Details

## Sills

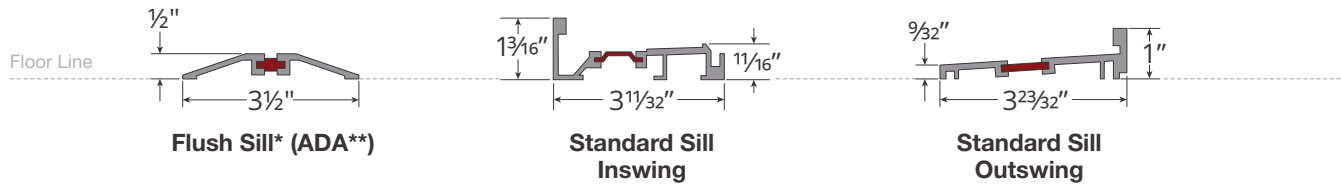

## Vertical & Horizontal Rails

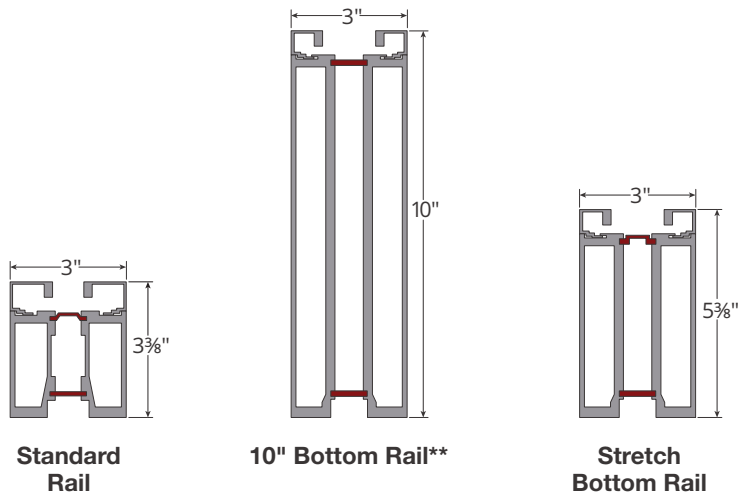

Scan to learn more.

**THERMA TRU**  
DOORS





EXPAND THE HORIZON

# Folding Glass Doors

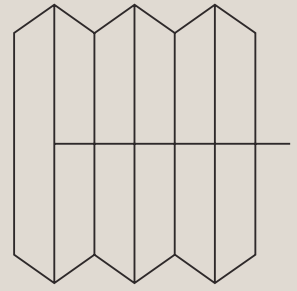



---

## Possibilities unfold.

Veris folding glass doors are perfect for connecting indoor and outdoor spaces in homes with patios, decks, enclosed porches and more. These operable walls offer a flexible and customizable opening, including an optional swing door, that allows the user to easily enter or exit a room without opening all the panels.



# Confidence in a Complete System

Create the ultimate open-air living experience with superior performance thanks to our full-system approach. With the Veris™ collection, each piece is engineered to work together seamlessly. Folding doors are available in top-load and bottom-load systems.

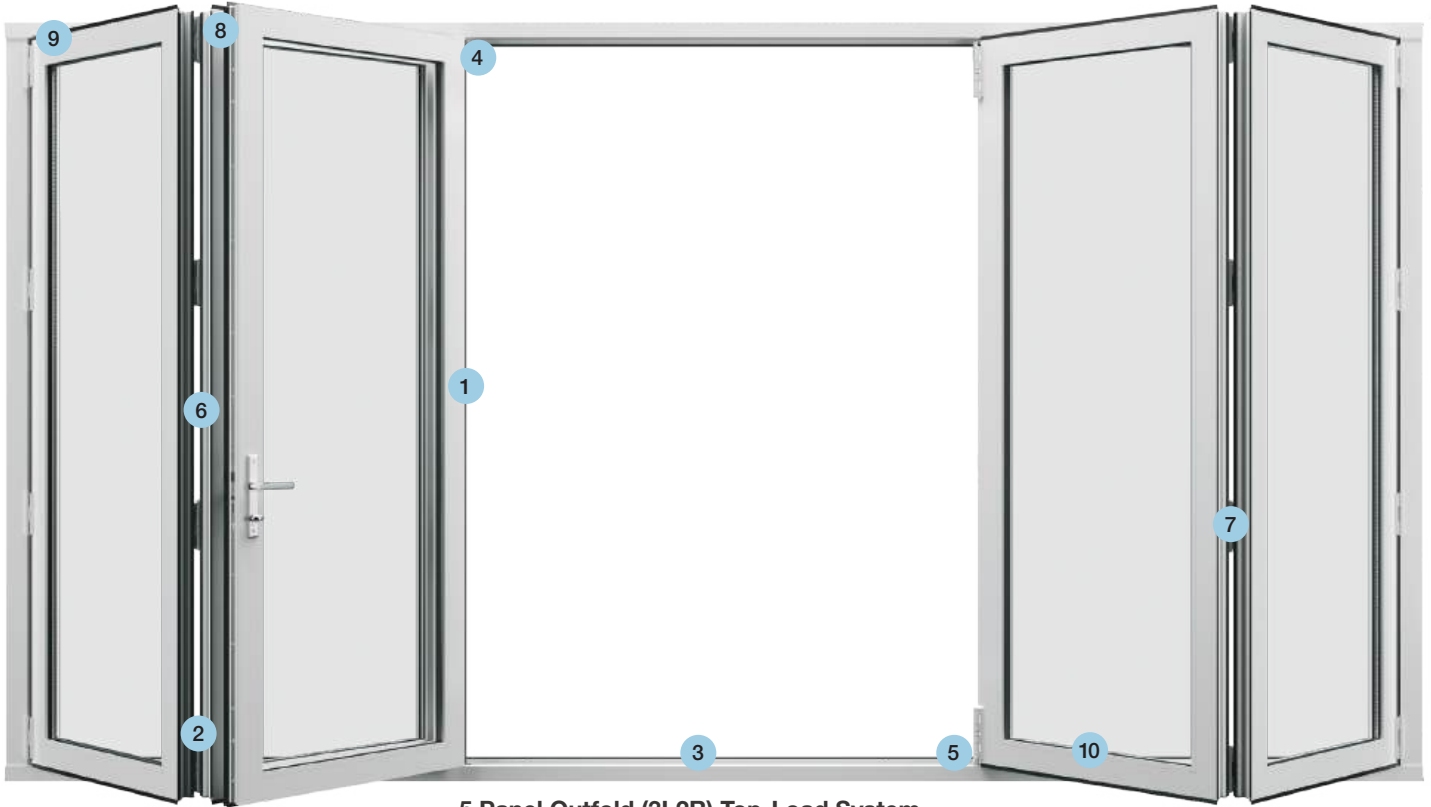

**5 Panel Outfold (3L2R) Top-Load System**  
Shown from the exterior side of the door system.



**1**  
Cutaway to show internal details.

**Thermal break design** separates interior and exterior aluminum to reduce heat and cold transfer between indoors and outdoors which helps reduce condensation.



**Semi-concealed hinges** built into the panels blend with the door system. Manufactured in-house to high tolerances under tight quality control. Color match options are available.

\*Door systems built with a flush sill have little resistance to water penetration and have a potential to leak if installed exposed to weather. We recommend these systems be installed away from weather under large soffits or overhangs.

\*\*For ADA compliance, the door must provide a minimum 32" clear opening width. Verify all other ADA compliance requirements with your local building code official.





Standard



Recessed Standard



Recessed Flush\*

**Thermally broken sills** reduce the transfer of heat and cold through the door system for greater energy efficiency while reducing condensation buildup.

Install as a **standard** or **recessed standard sill** for better water resistance, or a **recessed flush sill** for a seamless appearance.

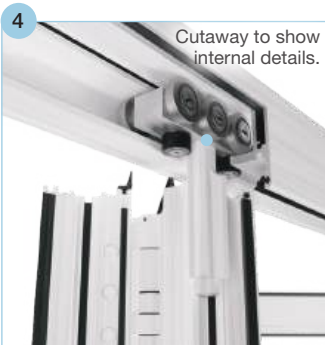

4 Cutaway to show internal details.

**Trolleys** carry the load of the door system from either the top or bottom of the assembly, depending on the hanging configuration. Assembled in-house with sealed precision ball bearings to help protect from dust and other debris for smooth and quiet operation.



5 Cutaway to show internal details.

Non-load-bearing **idlers** are designed to smoothly guide the door panels. Assembled in-house with sealed precision ball bearings to help protect from dust and other debris for smooth and quiet operation.



6

A **two-point lock** secures each panel against the compression seal for a tight bond. Designed for intuitive, ergonomic use while maintaining a low profile. Color match options are available.



7

**Hinge pulls** offer an easy, low-profile way to close door panels on outfold systems while helping to keep fingers away from pinch points. Made in-house to high tolerances. Color match options are available.



8

A **door catch** holds the door open. Made in-house for tight quality control. Color match options are available.



9

Designed to provide the best possible fit between panel and frame, **compression seals** help prevent water and air from entering the home.

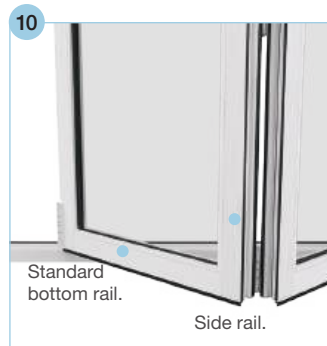

10 Standard bottom rail. Side rail.



10" bottom rail. Side rail.

**Top and side rails** are 3-3/8" wide, maximizing the view through each panel. Available with **standard bottom rails** that match the height of the top rail and width of the side rails or **10" bottom rails** which deliver the beauty of glass while meeting ADA compliance.\*\*

## V-2 vs. V-3



**V-2 Systems:  
Built for everyday life.**

Our V-2 systems are designed to meet the needs for most homes and structures. Featuring our standard components that are quality tested for long-term use, the V-2 system is perfect for residential dwellings in most areas of the United States.

**Panel & System  
Thickness: 2-1/4"**

**Maximum Height: 8'**



**V-3 Systems:  
Performance where you need it.**

Our V-3 systems are engineered to meet the high-performance needs of specific regions, building codes and commercial structures, and are built to support larger glass panels found in our taller units. With high-performance components that can stand up to heavy-duty use, the V-3 system is ideal for structures and door units that require extra support and stability.

**Panel & System Thickness: 3"**

**Maximum Height: 10'**

### Size Offering

Folding configurations with panels that exceed 8'0" in height will be built as a V-3 system.

System		2-Panel	3-Panel	4-Panel	5-Panel	6-Panel
Panel Width		3'0"	3'0"	3'0"	3'0"	3'0"
Height	6'8"					
	7'0"					
	8'0"					
	9'0"					
	10'0"					

 Standard Lead Time

 Extended Lead Time



# Configurations

Available as infold or outfold. Select configurations are available with single swing door operation for easy access to outdoor spaces without opening the entire folding unit. Look for the panels outlined in red.

Shown from the exterior side of the door system. See page 54 for structural and Impact-rated options.

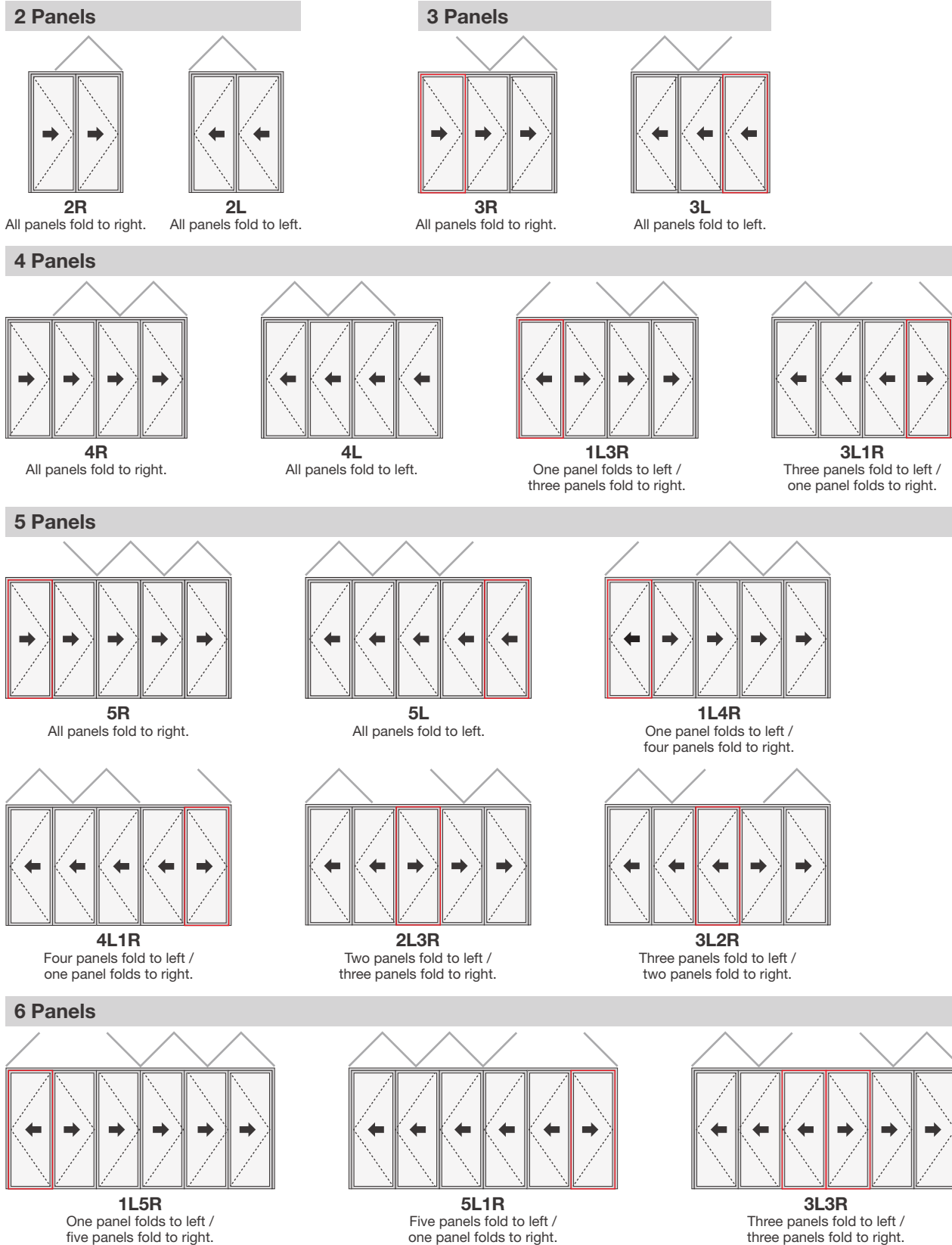



# Glass Options



### Enhanced Low-E

Blocks 95% of the sun's harmful UV rays, helping to preserve the color and materials of your interior furnishings, draperies and wall treatments.\*



### Low-E

Delivers exceptional energy efficiency, retaining heat in the winter and reflecting it in the summer.



### Turtle with Low-E

Tinted gray to reduce interior light projection as required near sea turtle nesting areas. Includes Low-E coating for exceptional energy efficiency.

## Optional Neat+™ Coating

All Low-E glass in the Veris collection is available with Neat+ coating. This low-maintenance coating is designed to help keep glass clear and free of watermarks, reducing the need for cleaning.\*



Without  
Neat+ Coating

With  
Neat+ Coating

## Divided Lites

### Available Patterns

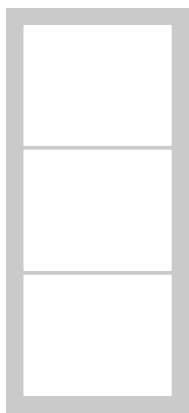

1X3

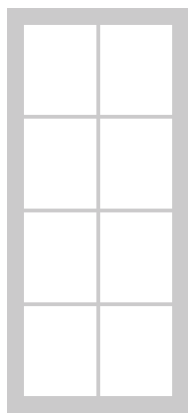

2X4

### Grilles Between Glass (GBGs)



GBGs are sealed between two panes of tempered glass for a smooth easy-to-clean surface.

Height:  $\frac{5}{8}$ "  
Depth:  $\frac{3}{16}$ "

### Finish Options for GBGs

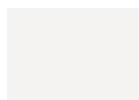

White



Black

Split finish not available for GBGs.

### Simulated Divided Lites (SDLs) with Grilles Between Glass (GBGs)

SDLs are adhered to the interior and exterior panes of tempered glass and are finished to complement the door system. For a more authentic divided lite look, SDLs are layered over black GBGs.



### Traditional Profile

Height:  $\frac{3}{4}$ "  
Depth:  $\frac{15}{32}$ "



### Flat Profile

Height:  $\frac{3}{4}$ "  
Depth:  $\frac{5}{32}$ "

## Screen Options by Genius

Welcome a fresh breeze into the home while keeping insects and debris out. Sheer screens glide open and shut with the touch of a finger and include convenient latching options at the center, right or left to best fit the home.

Screens are pre-assembled for fast and easy installation compared to other screens. For outfold systems, screens are installed on the interior side. For infold systems, screens are installed on the exterior side. Available in white and black.

### ZigZag2 Screens

- Designed to fit standard openings.
- Maximum Height: 8'
- Maximum Unit Width: 12'

### Sheer Classic Screens

- Designed to fit wide openings.
- Feature a thin flat bottom guide.
- Maximum Height: 10'
- Maximum Single Panel Width: 57-½"
- Overall Width Sized to Unit



Scan to learn more about screen options.

**THERMA TRU**  
DOORS



# Finish

Choose from an on-trend assortment of finishes designed to complement most homes.

## Standard Lead Powder Coated

Similar to semi-gloss finish.

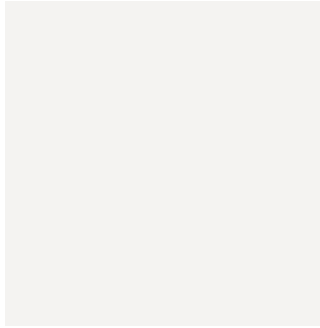

White



Black

## Standard Lead Anodized

Similar to eggshell finish.



Clear

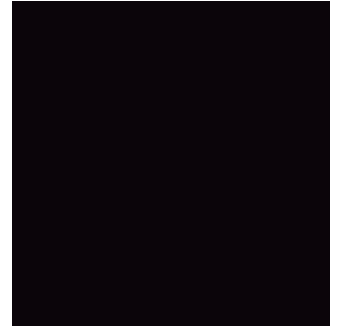

Dark Bronze

## Extended Lead Powder Coated

Similar to semi-gloss finish.

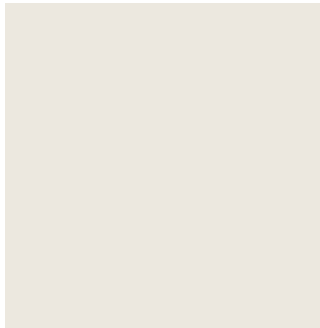

Bone White

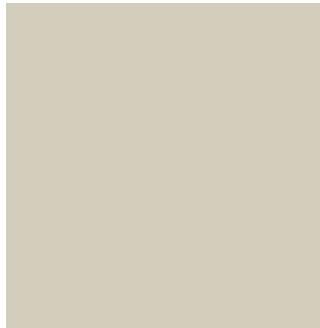

Sandstone



Fashion Gray



Charcoal



White / Black

### Additional Split Finish Options

Choose any two colors to create a split finish that complements the interior and exterior of the home. Available on extended lead time.

Order 3-1/8" x 4" samples of finish colors at [store.thermatru.com](http://store.thermatru.com).

# Sills



Standard / Recessed Standard



Recessed Flush\*

### Sill Finish Options

- Clear Anodized
- Dark Bronze Anodized



# Handlesets

Active handlesets come standard with thumbturn interior lock with keyed exterior. See chart for availability.

The multi-point locking system engages the panel and frame at three points for enhanced security while helping to preserve the compression seal's hold, even under the pressure of high winds.



## Handleset Finish Options



Brass



Brushed Nickel



Black Nickel



Satin Nickel



Oil-Rubbed Bronze

## Availability

	Brass	Brushed Nickel	Black Nickel	Satin Nickel	Oil-Rubbed Bronze
Heirloom	Standard Lead Time	Extended Lead Time	Not Available	Standard Lead Time	Standard Lead Time
Venture	Standard Lead Time	Extended Lead Time	Extended Lead Time	Standard Lead Time	Standard Lead Time
Millennium	Standard Lead Time	Extended Lead Time	Extended Lead Time	Standard Lead Time	Standard Lead Time
Realm	Standard Lead Time	Not Available	Not Available	Standard Lead Time	Standard Lead Time



Standard Lead Time



Extended Lead Time



Not Available

\*Door systems built with a flush sill have little resistance to water penetration and have a potential to leak if installed exposed to weather. We recommend these systems be installed away from weather under large soffits or overhangs.

Note: Finish colors may vary from an actual application due to fluctuations in finishing or printing. See your Therma-Tru seller for details on the Veris collection limited finish warranty and exclusions.

# V-2 Details

**Thermal Break** Veris glass door systems feature thermal breaks, shown here in red.

## Top- & Bottom-Load Sills

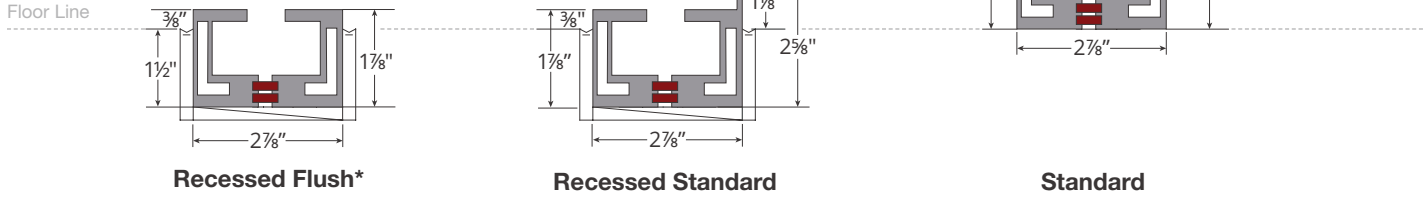

## Vertical & Horizontal Rails

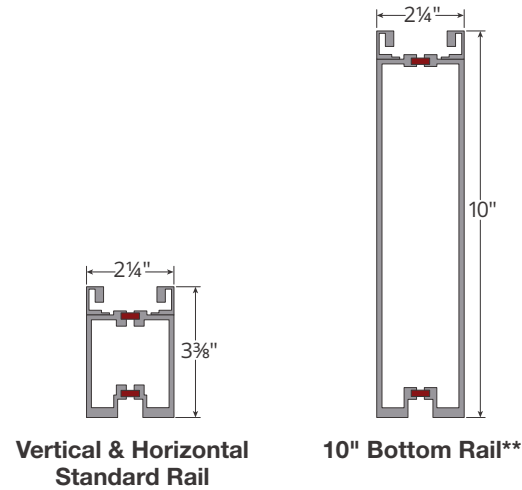

\*Door systems built with a flush sill have little resistance to water penetration and have a potential to leak if installed exposed to weather. We recommend these systems be installed away from weather under large soffits or overhangs.

\*\*For ADA compliance, the door must provide a minimum 32" clear opening width. Verify all other ADA compliance requirements with your local building code official.



# V-3 Details

## Top- & Bottom-Load Sills

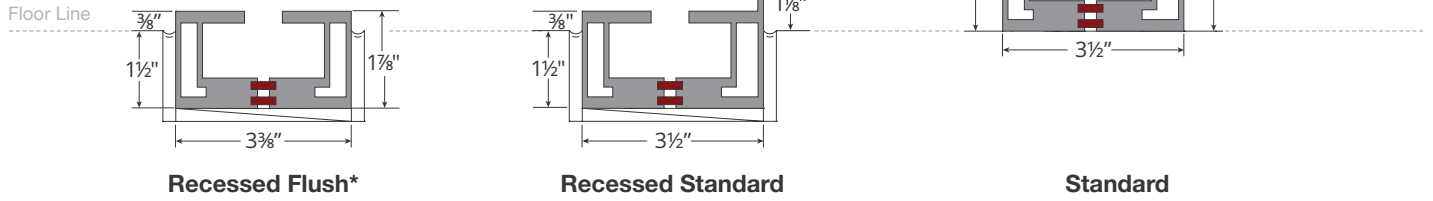

## Vertical & Horizontal Rails

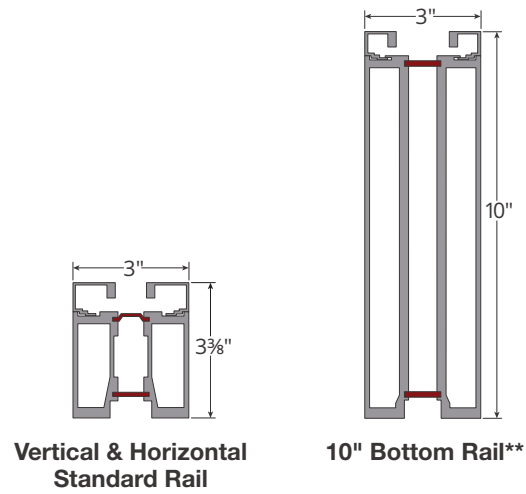

Scan to learn more.

**THERMA TRU**  
DOORS





# Sliding Glass Doors

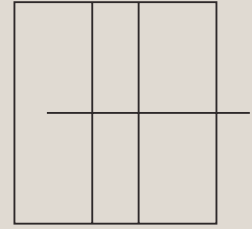





## Expand the living space.

Easily blend indoor and outdoor living spaces with Veris sliding glass door systems. Enjoy expansive views thanks to a flexible design with large panel sizes and multiple configurations. Options for built-in pocket doors deliver completely unobstructed views when fully opened.

# Confidence in a Complete System

Create the ultimate open-air living experience with superior performance thanks to our full-system approach. With the Veris™ collection, each piece is engineered to work together seamlessly.

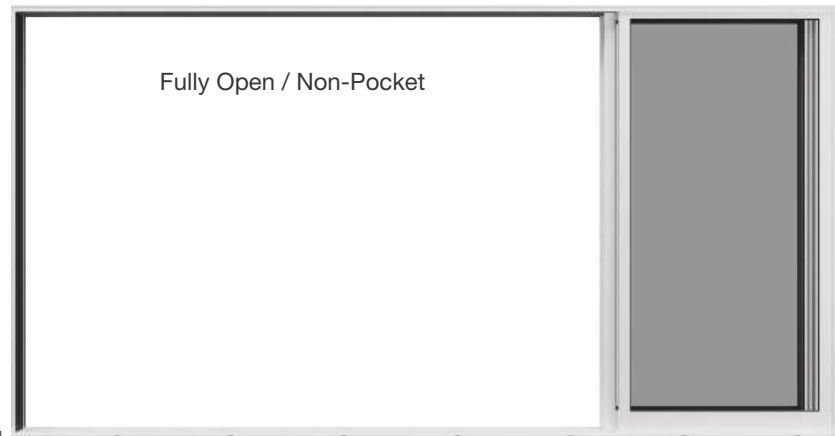





**Standard**

**Thermally broken sills** reduce the transfer of heat and cold through the door system for greater energy efficiency while reducing condensation buildup. Sills are available in **standard** and **flush** configurations.



**Flush\***

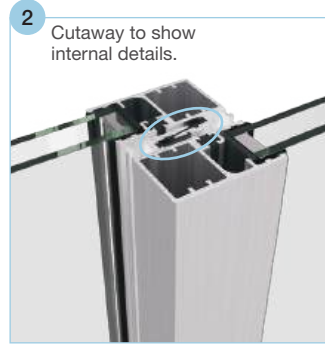

2 Cutaway to show internal details.

A **hook rail** seals the opening between two closed panels to keep out drafts and the elements.

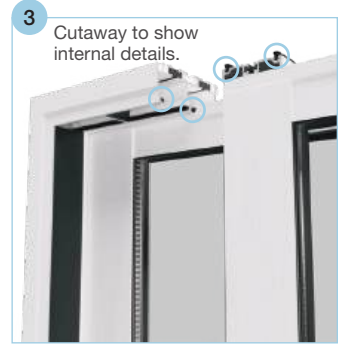

3 Cutaway to show internal details.

Designed to provide the best possible fit between panel and frame, the **weatherstrip** blocks moisture and drafts from entering the home.

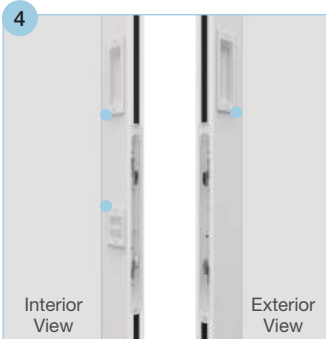

The **Recessed handleset** offers clean style and is made in-house for quality control.

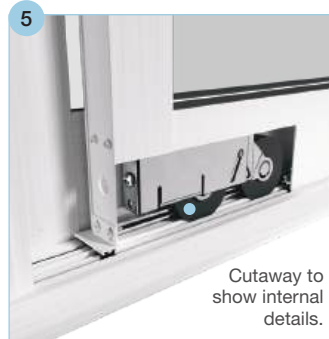

4

Engineered for smooth operation, **polymer rollers** quietly move door panels with precision **ball bearings** for sustained durability.



5

As part of a pocket unit, the **edge pull** begins the movement of the door panels when they are open. Made in-house for quality control.

This image not shown in system to the left.

\*Door systems built with a flush sill have little resistance to water penetration and have a potential to leak if installed exposed to weather. We recommend these systems be installed away from weather under large soffits or overhangs.



# V-2 Systems: Built for everyday life.

Our V-2 systems are designed to meet the needs for most homes and structures. Featuring our standard components that are quality tested for long-term use, the V-2 system is perfect for residential dwellings in most areas of the United States.

**Maximum Height: 10'**



## Size Offering

System		2-Panel 2R, 2L				3-Panel 3R, 3L, 2L1R, 1L, 2R			3-Panel Pocket 3RP, 3LP			4-Panel 4R, 4L, 2L2R			4-Panel Pocket 4RP, 4LP			
		Width	2'6"	3'0"	4'0"	5'0"	3'0"	4'0"	5'0"	3'0"	4'0"	5'0"	3'0"	4'0"	5'0"	3'0"	4'0"	5'0"
Height	6'8"																	
	7'0"																	
	8'0"																	
	9'0"																	
	10'0"																	

Standard Lead Time
  Extended Lead Time



# Configurations

Shown from the exterior side of the door system. See page 54 for structural and Impact-rated options.

## 2 Panels

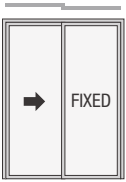

**Left panel slides behind right panel.**

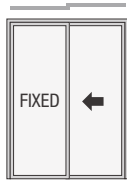

**Right panel slides behind left panel.**

## 3 Panels

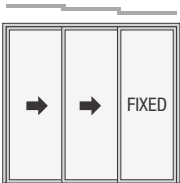

**Left two panels slide behind right panel.**

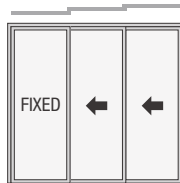

**Right two panels slide behind left panel.**

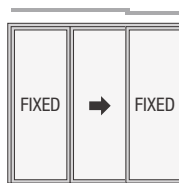

**Center panel slides behind right panel.**

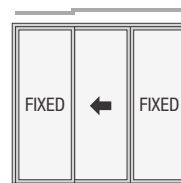

**Center panel slides behind left panel.**

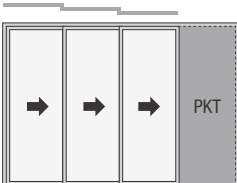

**All three panels slide into a pocket to the right.**

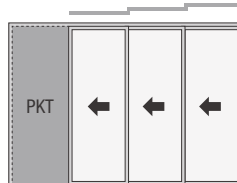

**All three panels slide into a pocket to the left.**

## 4 Panels

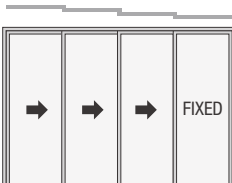

**Left three panels slide behind right panel.**



**Right three panels slide behind left panel.**

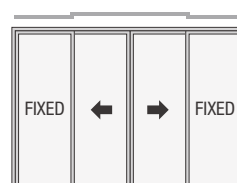

**Two center panels slide behind each outer panel.**



**All four panels slide into a pocket to the right.**

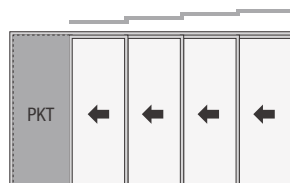

**All four panels slide into a pocket to the left.**



# Glass Options



### Enhanced Low-E

Blocks 95% of the sun's harmful UV rays, helping to preserve the color and materials of your interior furnishings, draperies and wall treatments.\*



### Low-E

Delivers exceptional energy efficiency, retaining heat in the winter and reflecting it in the summer.



### Turtle with Low-E

Tinted gray to reduce interior light projection as required near sea turtle nesting areas. Includes Low-E coating for exceptional energy efficiency.

## Optional Neat+™ Coating

All Low-E glass in the Veris collection is available with Neat+ coating. This low-maintenance coating is designed to help keep glass clear and free of watermarks, reducing the need for cleaning.\*



Without  
Neat+ Coating

With  
Neat+ Coating

## Divided Lites

### Available Patterns



1X3

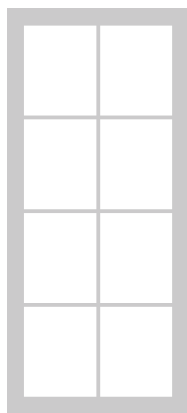

2X4

### Grilles Between Glass (GBGs)



GBGs are sealed between two panes of tempered glass for a smooth easy-to-clean surface.

Height:  $\frac{5}{8}$ "  
Depth:  $\frac{3}{16}$ "

### Finish Options for GBGs

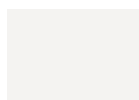

White



Black

Split finish not available for GBGs.

### Simulated Divided Lites (SDLs) with Grilles Between Glass (GBGs)

SDLs are adhered to the interior and exterior panes of tempered glass and are finished to complement the door system. For a more authentic divided lite look, SDLs are layered over black GBGs.



### Flat Profile

Height:  $\frac{3}{4}$ "  
Depth:  $\frac{5}{32}$ "

## Screen Options by Genius

Welcome a fresh breeze into the home while keeping insects and debris out. Sheer screens glide open and shut with the touch of a finger and include convenient latching options at the center, right or left to best fit the home.

Screens are pre-assembled for fast and easy installation compared to other screens. Screens are installed on the exterior side. Available in white and black.

### ZigZag2 Screens

- Designed to fit standard openings.
- Maximum Height: 8'
- Maximum Unit Width: 12'

### Sheer Classic Screens

- Designed to fit wide openings.
- Feature a thin flat bottom guide.
- Maximum Height: 10'
- Maximum Single Panel Width: 57-½"
- Overall Width Sized to Unit



Scan to learn more about screen options.

**THERMA TRU**  
DOORS



# Finish

Choose from an on-trend assortment of finishes designed to complement most homes.

## Standard Lead Powder Coated

Similar to semi-gloss finish.

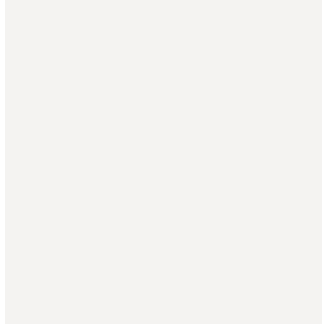

White



Black

## Standard Lead Anodized

Similar to eggshell finish.



Clear

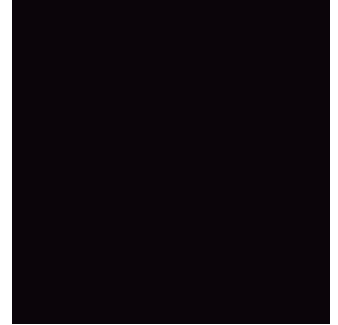

Dark Bronze

## Extended Lead Powder Coated

Similar to semi-gloss finish.

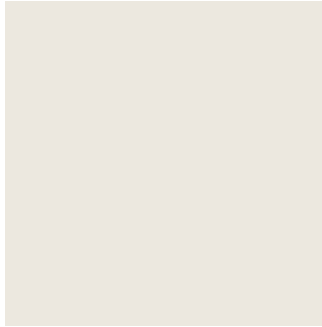

Bone White

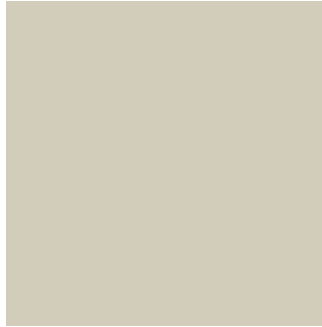

Sandstone



Fashion Gray

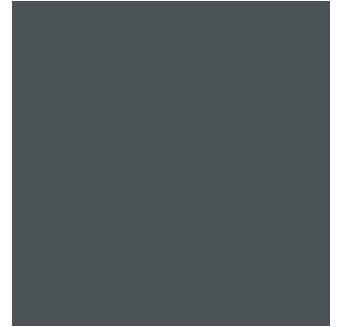

Charcoal

Order 3-1/8" x 4" samples  
of finish colors at  
[store.thermatru.com](http://store.thermatru.com).

# Sills



Standard Sill



Flush Sill\*

## Sill Finish Options

- Clear Anodized
- Dark Bronze Anodized

\*Door systems built with a flush sill have little resistance to water penetration and have a potential to leak if installed exposed to weather. We recommend these systems be installed away from weather under large soffits or overhangs.

Note: Finish colors may vary from an actual application due to fluctuations in finishing or printing. See your Thermo-Tru seller for details on the Veris collection limited finish warranty and exclusions.



# Handlesets

Active handlesets come standard with thumbturn interior lock with keyed exterior.

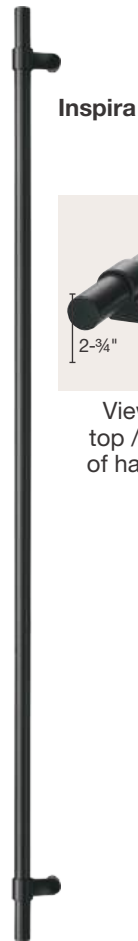

View from top / bottom of handleset.

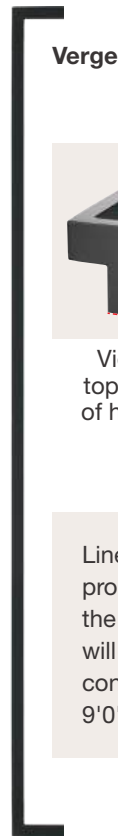

View from top / bottom of handleset.

Linear pulls are sized proportionally to the door height and will feature a third connection point for 9'0" and 10'0" doors.

## Handleset Finish Options

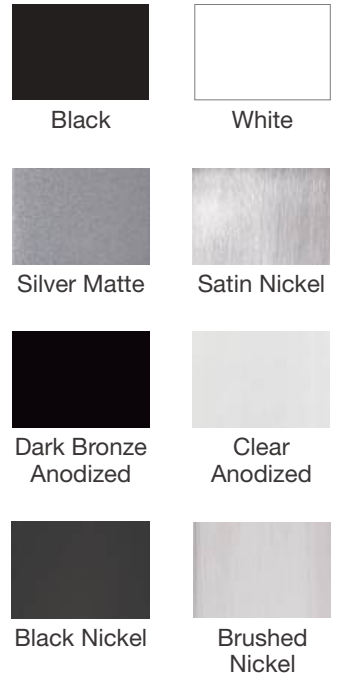

Inspira and Verge handlesets deliver the minimalist style of a modern door pull. Features a lock with thumbturn on the interior.

## Availability

	Black	White	Silver Matte	Satin Nickel	Dark Bronze Anodized	Clear Anodized	Black Nickel	Brushed Nickel
<b>Ergonomic</b>								
<b>Inspira</b>								
<b>Verge</b>								
<b>Recessed</b>								

Standard Lead Time
 
 Extended Lead Time
 

 Not Available

# V-2 Details

**Thermal Break** Veris glass door systems feature thermal breaks, shown here in red.

## Sills

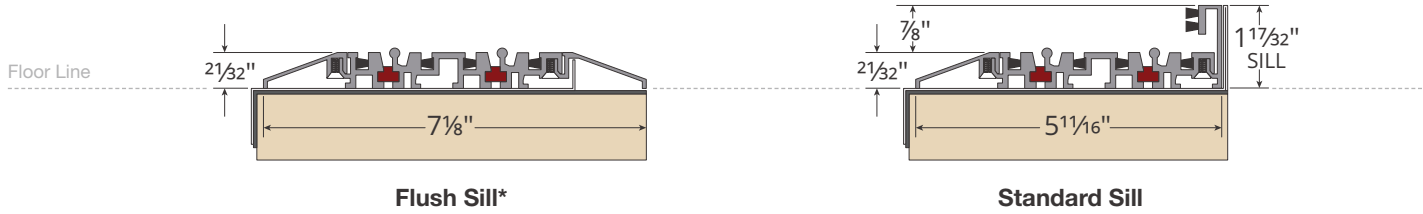

## Vertical & Horizontal Rails

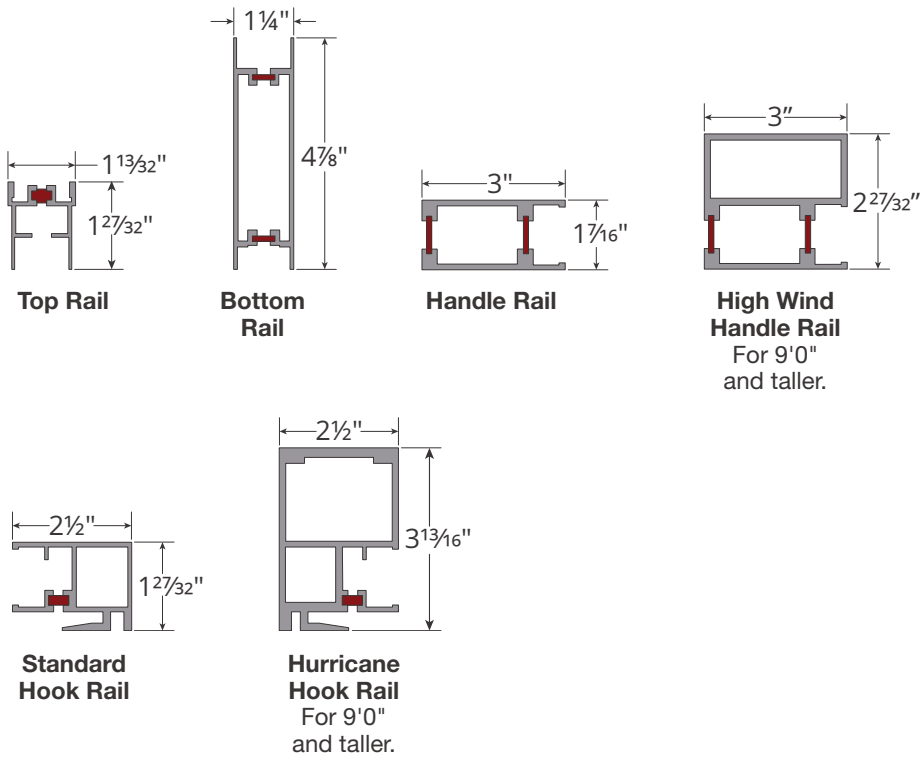

Scan to learn more.





# Structural & Impact-Rated Options



## Impact-Rated Products

Therma-Tru offers Impact-rated doors and glass that can be used to meet high-wind and coastal region codes and regulations, offering excellent performance in extreme weather conditions while providing added protection.

Constructed to help protect the interior of the home from flying debris and high winds associated with tropical storms and hurricanes, these products are tested to meet codes and regulations in coastal regions, including parts of Florida, Texas and the Carolinas.\*

\*Product approvals show that the door system meets applicable codes when selected, assembled and installed as instructed.

Note: Visit [www.VerisCollection.com](http://www.VerisCollection.com) for product approvals and installation instructions. Always confirm building code requirements in your area before buying. Follow weather and news reports to assess severe weather situations and obey local authorities' shelter and evacuation orders. No product guarantees safety for persons or property, nor makes any premises hurricane- or impact-proof.



Scan to find product approvals.

## Size Offering

### Hinged

System		Single					French						
Panel Width		2'6"	2'8"	2'10"	3'0"	3'6"	4'0"	2'6"	2'8"	2'10"	3'0"	3'6"	4'0"
Height	6'8"												
	7'0"												
	8'0"												
	9'0"												
	10'0"												

### Folding

System		2-Panel	3-Panel	4-Panel	5-Panel	6-Panel
Panel Width		3'0"	3'0"	3'0"	3'0"	3'0"
Height	6'8"					
	7'0"					
	8'0"					
	9'0"					
	10'0"					

### Sliding

System		2-Panel 2R, 2L				3-Panel 3R, 3L, 2L1R, 1L, 2R			3-Panel Pocket 3RP, 3LP			4-Panel 4R, 4L, 2L2R			4-Panel Pocket 4RP, 4LP		
Width		2'6"	3'0"	4'0"	5'0"	3'0"	4'0"	5'0"	3'0"	4'0"	5'0"	3'0"	4'0"	5'0"	3'0"	4'0"	5'0"
Height	6'8"																
	7'0"																
	8'0"																



Standard Lead Time



Extended Lead Time



Not Available



Explore all available options  
in Entryway Developer Pro.

















**THERMA TRU**<sup>®</sup>  
DOORS

Where Home Begins<sup>™</sup>

[thermatru.com](http://thermatru.com)

1-800-THERMA-TRU (843-7628)

1750 Indian Wood Circle  
Maumee, OH 43537



#thermatru